

nex[®]

Protezioni in alluminio tubolare per edilizia e urbanistica

Catalogo delle applicazioni



nex[®]

nex[®] protezioni verticali per edilizia e urbanistica è un sistema modulare dal design innovativo ideato con il massimo rigore estetico e funzionale: fabbricato basicamente in alluminio permette l'integrazione di altri materiali di alta qualità come legno, vetro, cavi d'acciaio e pannelli fenolici.

nex®



- Applicazioni per ambienti **interni ed esterni**. Ringhiere, parapetti per balconi, inferriate, recinzioni, barriere, etc.
- **Concezione del progetto**: consegna del sistema **prefabbricato su misura, pronto per la posa in opera a lavori terminati**.
- **Modulare e aricolato**. Facilmente adattabile a qualsiasi pendenza e tracciato. Si installa rapidamente, non richiede operazioni specializzate in corrispondenza di **scale e rampe**.
- Versatilità. Gran **varietà di configurazioni** a seconda delle necessità funzionali.
- **Espressività estetica** e formale di ampio registro. Si adatta facilmente a vari tipi di ambienti grazie alla varietà di risorse compositive, materiali (legno, vetro, pannelli fenolici, cavi d'acciaio, etc.) e finiture di superficie.
- **Due gamme** di prestazioni strutturali. Profili **leggeri o robusti**.
- Impiego esclusivo di materiali inossidabili, garanzia di **lunga durata**.
- **Prezzi contenuti**.





INDICE

RINGHIERE

· Catalogo dei modelli	11
· Composizioni	25
· Schema di montaggio	26

CANCELLATE

· Catalogo dei modelli	29
· Composizioni	37
· Schema di montaggio	38

CORRIMANO

· Catalogo dei modelli	41
· Composizioni	49
· Schema di montaggio	50

PARAPETTI

· Catalogo dei modelli	53
· Composizioni	59
· Schema di montaggio	60

BALCONI

· Catalogo dei modelli	63
· Composizioni	69
· Schema di montaggio	70

RINGHIERE CON PANNELLI FUORI SOLETTA

· Catalogo dei modelli	73
· Composizioni	77
· Schema di montaggio	78

PARETI DIVISORIE

· Catalogo dei modelli	81
· Composizioni	87
· Schema di montaggio	88





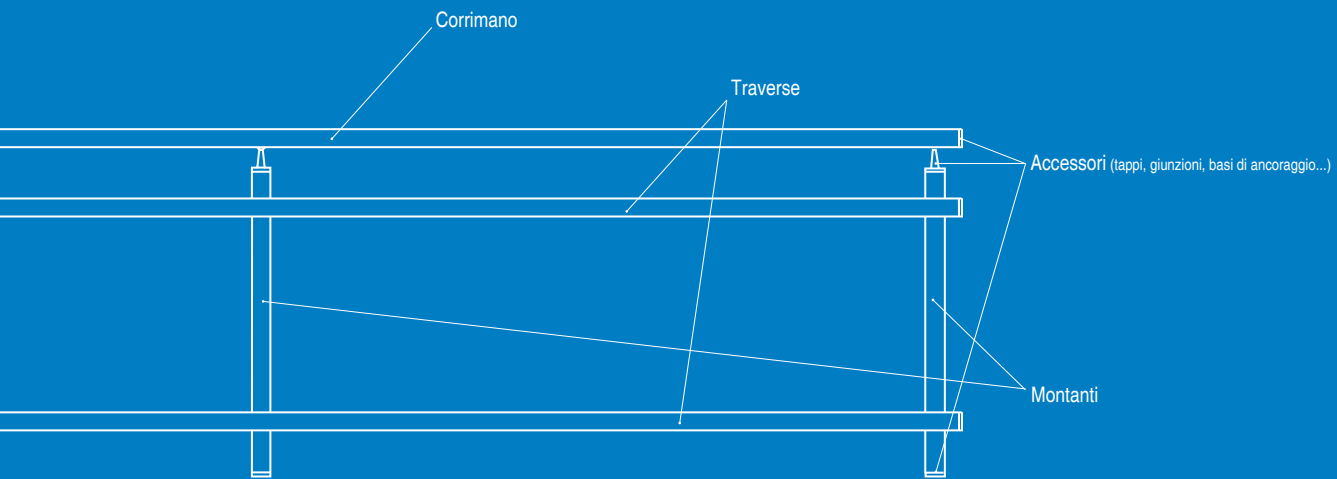

DATI TECNICI	91
--------------------	----



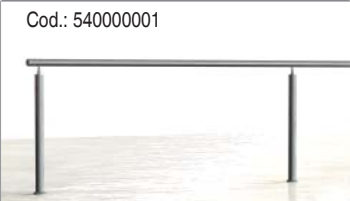
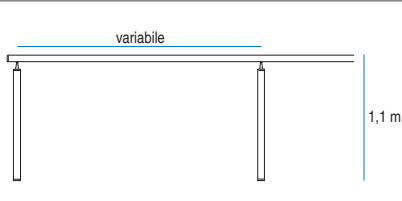

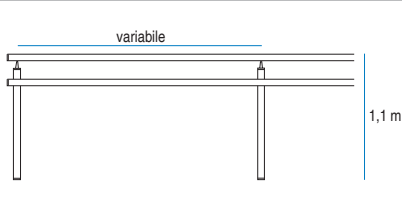
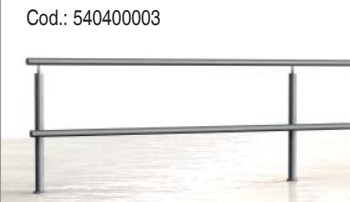
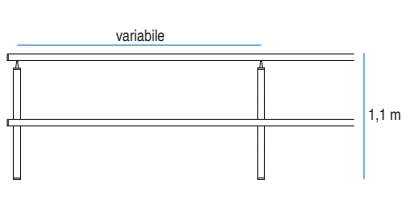
GAMMA COLORI	94
--------------------	----

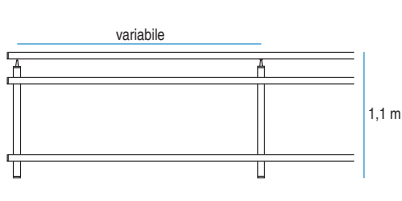

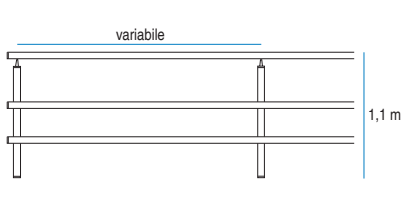

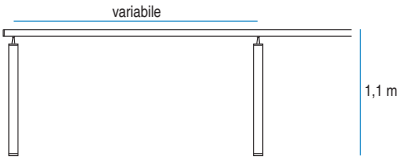

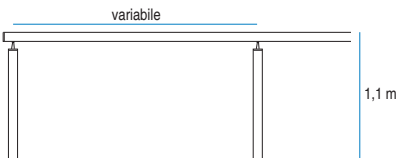

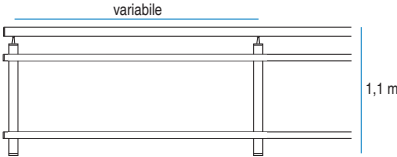
GESTIONE E CONSEGNA	95
---------------------------	----

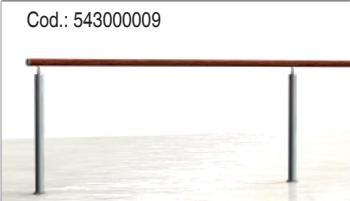
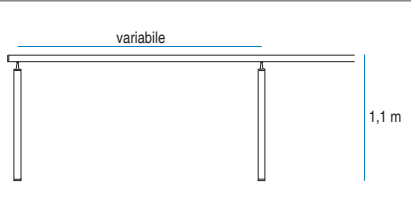

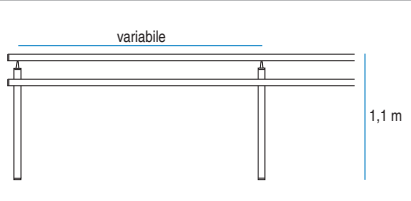

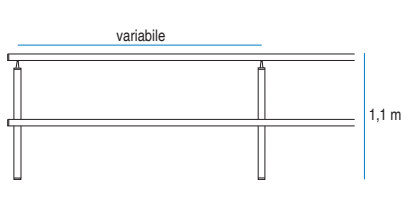

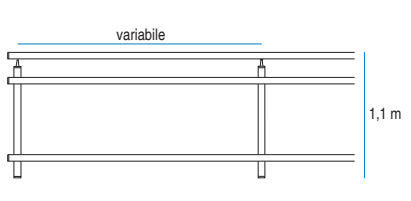

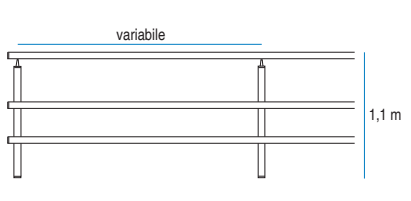

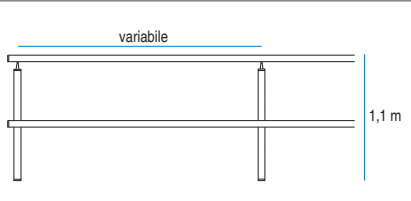

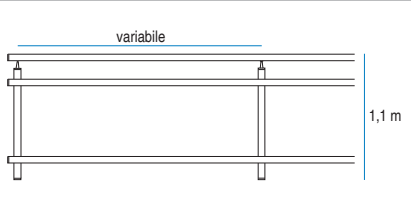

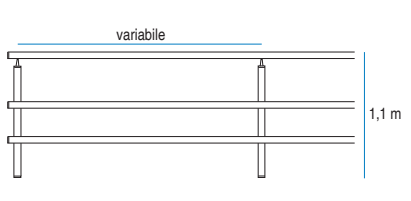

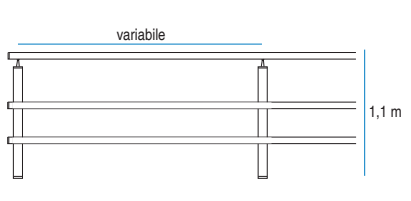

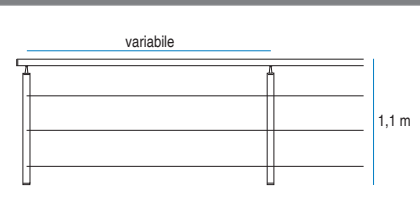
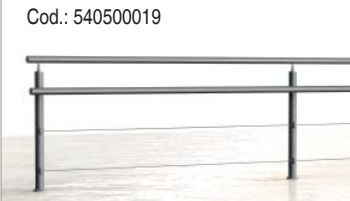
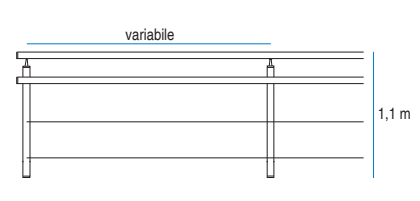

MODELLO E CODICE	Elementi e materiali	Finiture (V. colori a pag. 95)	Dimensioni
Cod.: 54000001 	Corrimano leggero (Alluminio estruso) Montanti leggeri (Alluminio estruso) Accessori (Inox)	<ul style="list-style-type: none"> • Alluminio estruso <ul style="list-style-type: none"> Laccato Sublimato effetto "legno" Anodizzato • Inox <ul style="list-style-type: none"> Laccato 	
Cod.: 540400002 	Corrimano leggero (Alluminio estruso) Montanti leggeri (Alluminio estruso) Traversa leggera (Alluminio estruso) Accessori (Inox)	<ul style="list-style-type: none"> • Alluminio estruso <ul style="list-style-type: none"> Laccato Sublimato effetto "legno" Anodizzato • Inox <ul style="list-style-type: none"> Laccato 	
Cod.: 540400003 	Corrimano leggero (Alluminio estruso) Montanti leggeri (Alluminio estruso) Traversa leggera (Alluminio estruso) Accessori (Inox)	<ul style="list-style-type: none"> • Alluminio estruso <ul style="list-style-type: none"> Laccato Sublimato effetto "legno" Anodizzato • Inox <ul style="list-style-type: none"> Laccato 	
Cod.: 540400004 	Corrimano leggero (Alluminio estruso) Montanti leggeri (Alluminio estruso) Traverse leggere (Alluminio estruso) Accessori (Inox)	<ul style="list-style-type: none"> • Alluminio estruso <ul style="list-style-type: none"> Laccato Sublimato effetto "legno" Anodizzato • Inox <ul style="list-style-type: none"> Laccato 	
Cod.: 540400005 	Corrimano leggero (Alluminio estruso) Montanti leggeri (Alluminio estruso) Traverse leggere (Alluminio estruso) Accessori (Inox)	<ul style="list-style-type: none"> • Alluminio estruso <ul style="list-style-type: none"> Laccato Sublimato effetto "legno" Anodizzato • Inox <ul style="list-style-type: none"> Laccato 	

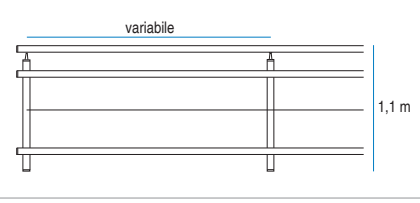
MODELLO E CODICE	Elementi e materiali	Finiture (V. colori a pag. 95)	Dimensioni
<p>Cod.: 54200006</p> 	<p>Corrimano leggero (Alluminio estruso) Montanti robusti (Alluminio estruso) Accessori (Inox)</p>	<ul style="list-style-type: none"> • Alluminio estruso Laccato Sublimato effetto "legno" Anodizzato • Inox Laccato 	
<p>Cod.: 54100007</p> 	<p>Corrimano robusto (Alluminio estruso) Montanti robusti (Alluminio estruso) Accessori (Inox)</p>	<ul style="list-style-type: none"> • Alluminio estruso Laccato Sublimato effetto "legno" Anodizzato • Inox Laccato 	
<p>Cod.: 54240008</p> 	<p>Corrimano robusto (Alluminio estruso) Montanti robusti (Alluminio estruso) Traverse leggere (Alluminio estruso) Accessori (Inox)</p>	<ul style="list-style-type: none"> • Alluminio estruso Laccato Sublimato effetto "legno" Anodizzato • Inox Laccato 	

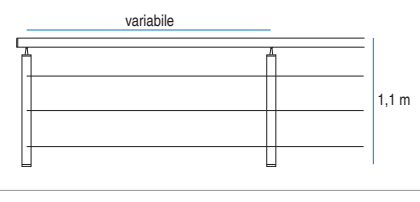
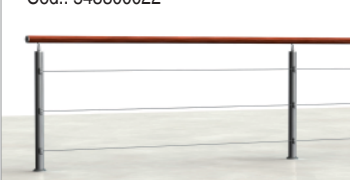
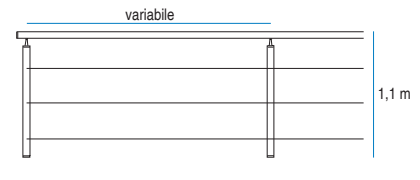
MODELLO E CODICE	Elementi e materiali	Finiture (V. colori a pag. 95)	Dimensioni
<p>Cod.: 54300009</p> 	<p>Corrimano leggero (Legno naturale) Montanti leggeri (Alluminio estruso) Accessori (Inox)</p>	<ul style="list-style-type: none"> • Legno naturale Castagno / Iroko • Alluminio estruso Laccato Sublimato effetto "legno" Anodizzato • Inox Laccato 	
<p>Cod.: 543400010</p> 	<p>Corrimano leggero (Legno naturale) Montanti leggeri (Alluminio estruso) Traversa leggera (Legno naturale) Accessori (Inox)</p>	<ul style="list-style-type: none"> • Legno naturale Castagno / Iroko • Alluminio estruso Laccato Sublimato effetto "legno" Anodizzato • Inox Laccato 	
<p>Cod.: 543400011</p> 	<p>Corrimano leggero (Legno naturale) Montanti leggeri (Alluminio estruso) Traversa leggera (Legno naturale) Accessori (Inox)</p>	<ul style="list-style-type: none"> • Legno naturale Castagno / Iroko • Alluminio estruso Laccato Sublimato effetto "legno" Anodizzato • Inox Laccato 	
<p>Cod.: 543400012</p> 	<p>Corrimano leggero (Legno naturale) Montanti leggeri (Alluminio estruso) Traverse leggere (Legno naturale) Accessori (Inox)</p>	<ul style="list-style-type: none"> • Legno naturale Castagno / Iroko • Alluminio estruso Laccato Sublimato effetto "legno" Anodizzato • Inox Laccato 	
<p>Cod.: 543400013</p> 	<p>Corrimano leggero (Legno naturale) Montanti leggeri (Alluminio estruso) Traverse leggere (Legno naturale) Accessori (Inox)</p>	<ul style="list-style-type: none"> • Legno naturale Castagno / Iroko • Alluminio estruso Laccato Sublimato effetto "legno" Anodizzato • Inox Laccato 	

MODELLO E CODICE	Elementi e materiali	Finiture (V. colori a pag. 95)	Dimensioni
<p>Cod.: 543400014</p> 	<p>Corrimano leggero (Legno naturale) Montanti leggeri (Alluminio estruso) Traversa leggera (Alluminio estruso) Accessori (Inox)</p>	<ul style="list-style-type: none"> • Legno naturale Castagno / Iroko • Alluminio estruso Laccato Sublimato effetto "legno" Anodizzato • Inox Laccato 	
<p>Cod.: 543400015</p> 	<p>Corrimano leggero (Legno naturale) Montanti leggeri (Alluminio estruso) Traverse leggere (Alluminio estruso e legno naturale) Accessori (Inox)</p>	<ul style="list-style-type: none"> • Legno naturale Castagno / Iroko • Alluminio estruso Laccato Sublimato effetto "legno" Anodizzato • Inox Laccato 	
<p>Cod.: 543400016</p> 	<p>Corrimano leggero (Legno naturale) Montanti leggeri (Alluminio estruso) Traverse leggere (Alluminio estruso) Accessori (Inox)</p>	<ul style="list-style-type: none"> • Legno naturale Castagno / Iroko • Alluminio estruso Laccato Sublimato effetto "legno" Anodizzato • Inox Laccato 	
<p>Cod.: 544400017</p> 	<p>Corrimano leggero (Legno naturale) Montanti robusti (Alluminio estruso) Traverse leggere (Legno naturale) Accessori (Inox)</p>	<ul style="list-style-type: none"> • Legno naturale Castagno / Iroko • Alluminio estruso Laccato Sublimato effetto "legno" Anodizzato • Inox Laccato 	

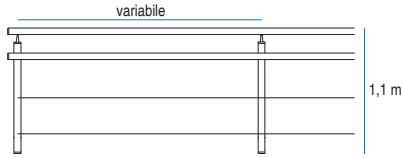
MODELLO E CODICE	Elementi e materiali	Finiture (V. colori a pag. 95)	Dimensioni
Cod.: 540300018 	Corrimano leggero (Alluminio estruso) Montanti leggeri (Alluminio estruso) Cavi (Inox) Accessori (Inox)	<ul style="list-style-type: none"> • Alluminio estruso Laccato Sublimato effetto "legno" Anodizzato • Inox Laccato 	
Cod.: 540500019 	Corrimano leggero (Alluminio estruso) Montanti leggeri (Alluminio estruso) Traversa leggera (Alluminio estruso) Cavi (Inox) Accessori (Inox)	<ul style="list-style-type: none"> • Alluminio estruso Laccato Sublimato effetto "legno" Anodizzato • Inox Laccato 	
Cod.: 540500020 	Corrimano leggero (Alluminio estruso) Montanti leggeri (Alluminio estruso) Traverse leggere (Alluminio estruso) Cavi (Inox) Accessori (Inox)	<ul style="list-style-type: none"> • Alluminio estruso Laccato Sublimato effetto "legno" Anodizzato • Inox Laccato 	
Cod.: 541300021 	Corrimano robusto (Alluminio estruso) Montanti robusti (Alluminio estruso) Cavi (Inox) Accessori (Inox)	<ul style="list-style-type: none"> • Alluminio estruso Laccato Sublimato effetto "legno" Anodizzato • Inox Laccato 	
Cod.: 543300022 	Corrimano leggero (Legno naturale) Montanti leggeri (Alluminio estruso) Cavi (Inox) Accessori (Inox)	<ul style="list-style-type: none"> • Legno naturale Castagno / Iroko • Alluminio estruso Laccato Sublimato effetto "legno" Anodizzato • Inox Laccato 	

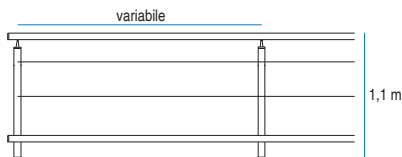
MODELLO E CODICE	Elementi e materiali	Finiture (V. colori a pag. 95)	Dimensioni
Cod.: 543500023 	Corrimano leggero (Legno naturale) Montanti leggeri (Alluminio estruso) Traversa leggera (Legno naturale) Cavi (Inox) Accessori (Inox)	<ul style="list-style-type: none"> • Legno naturale Castagno / Iroko • Alluminio estruso Laccato Sublimato effetto "legno" Anodizzato • Inox Laccato 	
Cod.: 543500024 	Corrimano leggero (Legno naturale) Montanti leggeri (Alluminio estruso) Traversa leggera (Alluminio estruso) Cavi (Inox) Accessori (Inox)	<ul style="list-style-type: none"> • Legno naturale Castagno / Iroko • Alluminio estruso Laccato Sublimato effetto "legno" Anodizzato • Inox Laccato 	





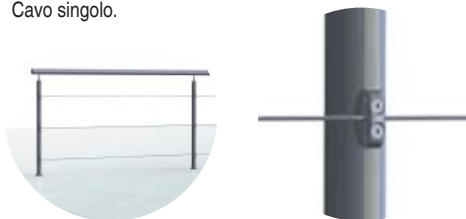

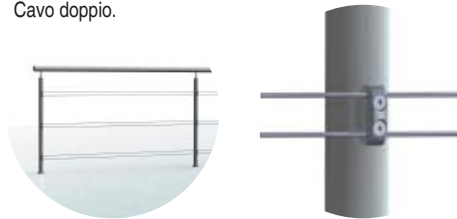

I modelli di ringhiera con cavo sono qui rappresentati nella forma standard con cavo singolo. Tutti i modelli possono tuttavia essere fabbricati con cavo doppio (ulteriori informazioni a pag. 94).

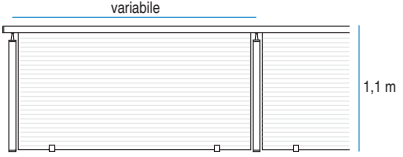

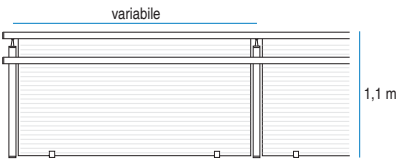

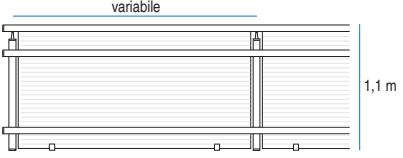

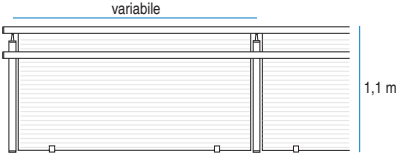

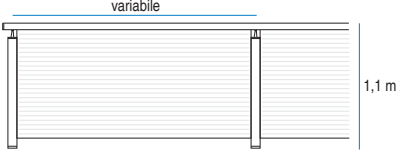
Cavo singolo.

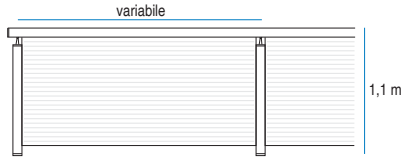

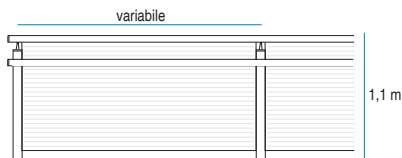
Cavo doppio.

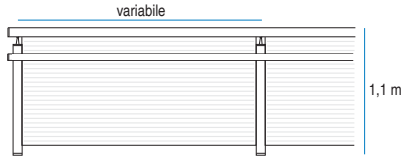

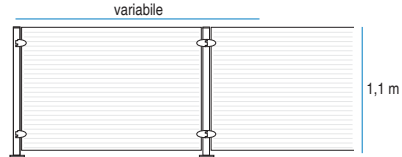
MODELLO E CODICE	Elementi e materiali	Finiture (V. colori a pag. 95)	Dimensioni
<p>Cod.: 541010025</p> 	<p>Corrimano leggero (Alluminio estruso) Montanti leggeri (Alluminio estruso) Accessori (Inox)</p> <p>*Fornito senza vetro. Spessore raccomandato 5+5 mm.</p>	<ul style="list-style-type: none"> • Alluminio estruso <ul style="list-style-type: none"> Laccato Sublimato effetto "legno" Anodizzato • Inox <ul style="list-style-type: none"> Laccato 	
<p>Cod.: 540600026</p> 	<p>Corrimano leggero (Alluminio estruso) Montanti leggeri (Alluminio estruso) Traversa leggera (Alluminio estruso) Accessori (Inox)</p> <p>*Fornito senza vetro. Spessore raccomandato 5+5 mm.</p>	<ul style="list-style-type: none"> • Alluminio estruso <ul style="list-style-type: none"> Laccato Sublimato effetto "legno" Anodizzato • Inox <ul style="list-style-type: none"> Laccato 	
<p>Cod.: 540600027</p> 	<p>Corrimano leggero (Alluminio estruso) Montanti leggeri (Alluminio estruso) Traverse leggere (Alluminio estruso) Accessori (Inox)</p> <p>*Fornito senza vetro. Spessore raccomandato 5+5 mm.</p>	<ul style="list-style-type: none"> • Alluminio estruso <ul style="list-style-type: none"> Laccato Sublimato effetto "legno" Anodizzato • Inox <ul style="list-style-type: none"> Laccato 	
<p>Cod.: 543600028</p> 	<p>Corrimano leggero (Alluminio estruso) Montanti leggeri (Alluminio estruso) Traversa leggera (Legno naturale) Accessori (Inox)</p> <p>*Fornito senza vetro. Spessore raccomandato 5+5 mm.</p>	<ul style="list-style-type: none"> • Legno naturale <ul style="list-style-type: none"> Castagno / Iroko • Alluminio estruso <ul style="list-style-type: none"> Laccato Sublimato effetto "legno" Anodizzato • Inox <ul style="list-style-type: none"> Laccato 	
<p>Cod.: 542100029</p> 	<p>Corrimano leggero (Alluminio estruso) Montanti robusti (Alluminio estruso) Accessori (Inox)</p> <p>*Fornito senza vetro. Spessore raccomandato 5+5 mm.</p>	<ul style="list-style-type: none"> • Alluminio estruso <ul style="list-style-type: none"> Laccato Sublimato effetto "legno" Anodizzato • Inox <ul style="list-style-type: none"> Laccato 	

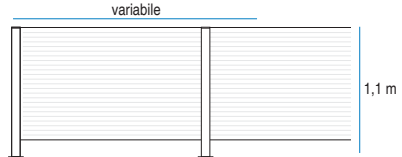
MODELLO E CODICE	Elementi e materiali	Finiture (V. colori a pag. 95)	Dimensioni
Cod.: 541100030 	Corrimano robusto (Alluminio estruso) Montanti robusti (Alluminio estruso) Accessori (Inox) *Fornito senza vetro. Spessore raccomandato 5+5 mm.	<ul style="list-style-type: none"> • Alluminio estruso <ul style="list-style-type: none"> Laccato Sublimato effetto "legno" Anodizzato • Inox <ul style="list-style-type: none"> Laccato 	
Cod.: 542600031 	Corrimano leggero (Alluminio estruso) Montanti robusti (Alluminio estruso) Traverse leggere (Alluminio estruso) Accessori (Inox) *Fornito senza vetro. Spessore raccomandato 5+5 mm.	<ul style="list-style-type: none"> • Alluminio estruso <ul style="list-style-type: none"> Laccato Sublimato effetto "legno" Anodizzato • Inox <ul style="list-style-type: none"> Laccato 	
Cod.: 542600032 	Corrimano robusto (Alluminio estruso) Montanti robusti (Alluminio estruso) Traverse leggere (Alluminio estruso) Accessori (Inox) *Fornito senza vetro. Spessore raccomandato 5+5 mm.	<ul style="list-style-type: none"> • Alluminio estruso <ul style="list-style-type: none"> Laccato Sublimato effetto "legno" Anodizzato • Inox <ul style="list-style-type: none"> Laccato 	
Cod.: 540200033 	Montanti leggeri (Alluminio estruso) Accessori (Inox) *Fornito senza vetro. Spessore raccomandato 5+5 mm.	<ul style="list-style-type: none"> • Alluminio estruso <ul style="list-style-type: none"> Laccato Sublimato effetto "legno" Anodizzato • Inox <ul style="list-style-type: none"> Laccato 	
Cod.: 541100034 	Montanti robusti (Alluminio estruso) Accessori (Inox) *Fornito senza vetro. Spessore raccomandato 5+5 mm.	<ul style="list-style-type: none"> • Alluminio estruso <ul style="list-style-type: none"> Laccato Sublimato effetto "legno" Anodizzato • Inox <ul style="list-style-type: none"> Laccato 	

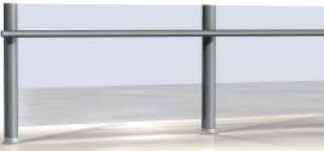
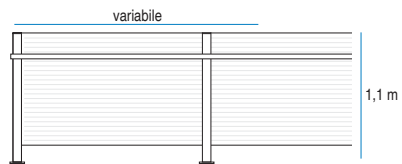
MODELLO E CODICE	Elementi e materiali	Finiture (V. colori a pag. 95)	Dimensioni
<p>Cod.: 542600035</p> 	<p>Montanti robusti (Alluminio estruso) Traversa leggera (Alluminio estruso) Accessori (Inox)</p> <p>*Fornito senza vetro. Spessore raccomandato 5+5 mm.</p>	<ul style="list-style-type: none"> · Alluminio estruso <ul style="list-style-type: none"> Laccato Sublimato effetto "legno" Anodizzato · Inox <ul style="list-style-type: none"> Laccato 	

Gamma colori dei pannelli fenolici (cartella colori TRESPA)

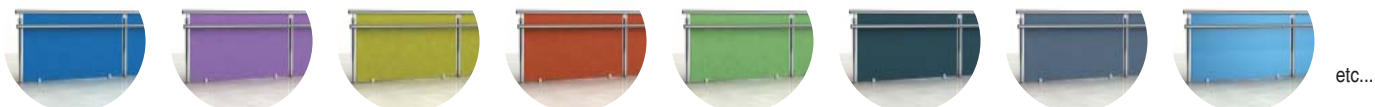

Pannelli fenolici personalizzati



MUSEO



Museo Etnográfico
Cantabria

* I piedi devono essere ancorati ad una base di cemento.

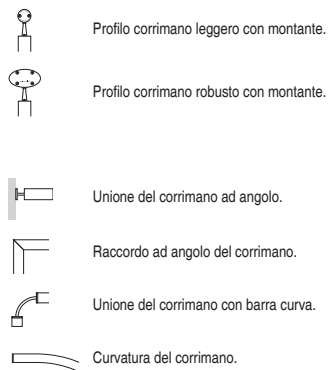
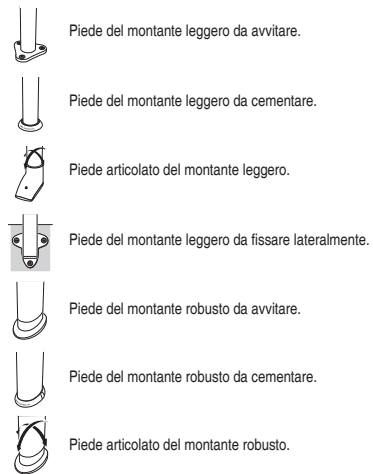
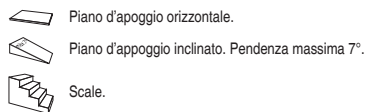

COMPOSIZIONI
ringhiere

PIANI D'APPOGGIO E MONTANTI

CORRIMANO E TERMINAZIONI

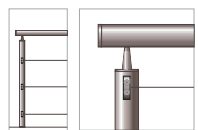
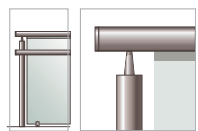
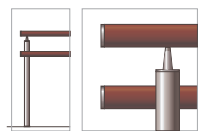
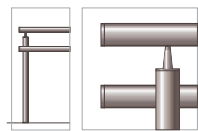

Alluminio + alluminio

Alluminio + legno naturale

Pannelli fenolici o di vetro

Cavi

	■	■		■	■	■	
			■	■			■
	■	■		■	■	■	
	■	■		■	■	■	
			■	■			■
	■	■		■	■	■	
	■	■		■	■	■	
			■	■			■
	■	■		■	■	■	

	■	■	■	■
	■	■	■	
	■		■	
	■	■	■	
	■		■	
	■	■	■	
	■	■	■	
	■	■	■	

SCHEMA DI MONTAGGIO ringhiere



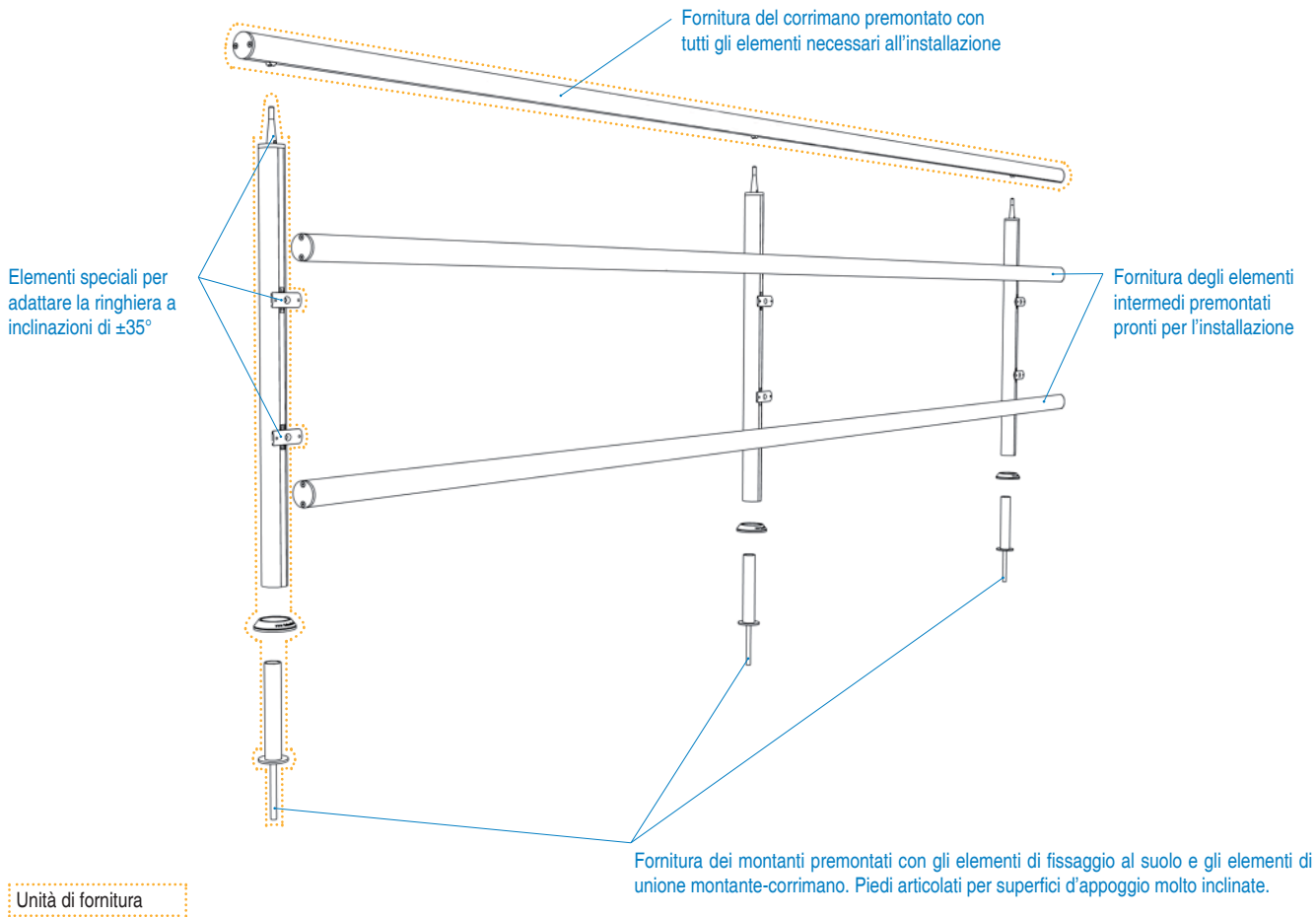



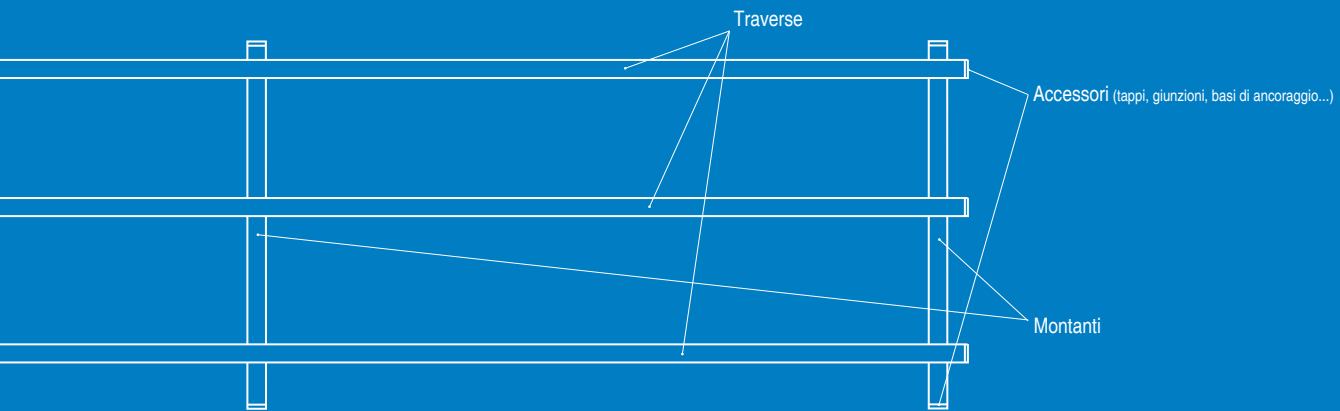

Fornitura di tutti gli elementi necessari all'installazione del prodotto (viteria, tasselli, chiavi speciali) riuniti e premontati in unità di fornitura. Il prodotto arriva in cantiere pronto per il montaggio.

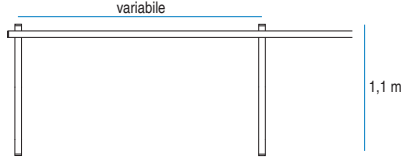

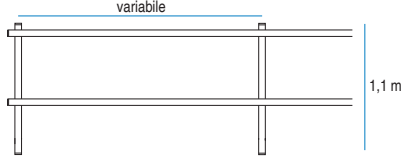

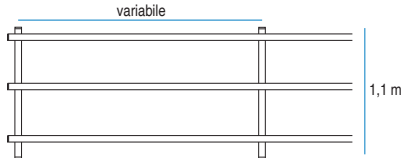

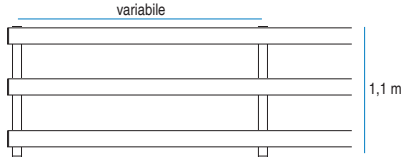

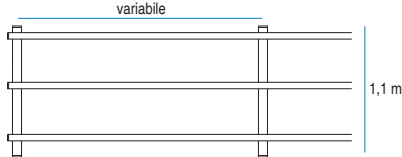

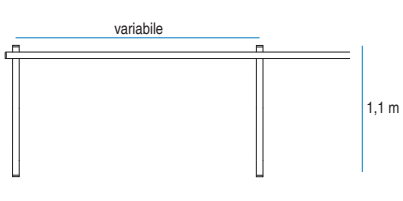

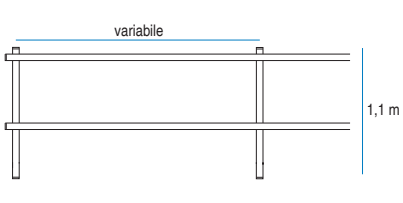

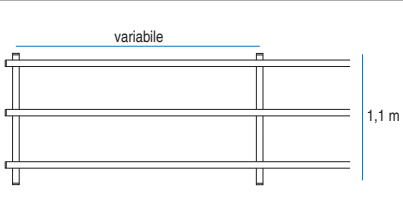



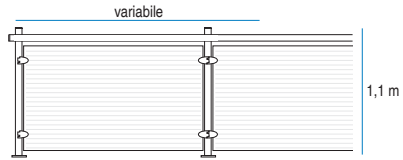

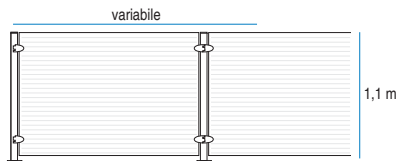

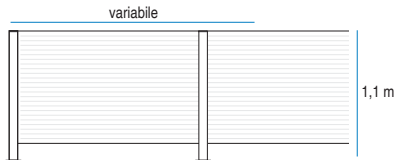
MODELLO E CODICE	Elementi e materiali	Finiture (V. colori a pag. 95)	Dimensioni
<p>Cod.: 540400036</p> 	<p>Montanti leggeri (Alluminio estruso) Traversa leggera (Alluminio estruso) Accessori (Inox)</p>	<ul style="list-style-type: none"> • Alluminio estruso <ul style="list-style-type: none"> Laccato Sublimato effetto "legno" Anodizzato • Inox <ul style="list-style-type: none"> Laccato 	
<p>Cod.: 540400037</p> 	<p>Montanti leggeri (Alluminio estruso) Traverse leggere (Alluminio estruso) Accessori (Inox)</p>	<ul style="list-style-type: none"> • Alluminio estruso <ul style="list-style-type: none"> Laccato Sublimato effetto "legno" Anodizzato • Inox <ul style="list-style-type: none"> Laccato 	
<p>Cod.: 540400038</p> 	<p>Montanti leggeri (Alluminio estruso) Traverse leggere (Alluminio estruso) Accessori (Inox)</p>	<ul style="list-style-type: none"> • Alluminio estruso <ul style="list-style-type: none"> Laccato Sublimato effetto "legno" Anodizzato • Inox <ul style="list-style-type: none"> Laccato 	
<p>Cod.: 541400039</p> 	<p>Montanti robusti (Alluminio estruso) Traverse robuste (Alluminio estruso) Accessori (Inox)</p>	<ul style="list-style-type: none"> • Alluminio estruso <ul style="list-style-type: none"> Laccato Sublimato effetto "legno" Anodizzato • Inox <ul style="list-style-type: none"> Laccato 	
<p>Cod.: 542400040</p> 	<p>Montanti robusti (Alluminio estruso) Traverse leggere (Alluminio estruso) Accessori (Inox)</p>	<ul style="list-style-type: none"> • Alluminio estruso <ul style="list-style-type: none"> Laccato Sublimato effetto "legno" Anodizzato • Inox <ul style="list-style-type: none"> Laccato 	

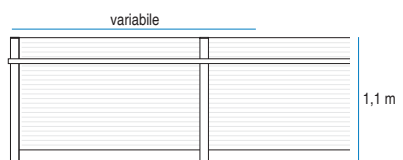
MODELLO E CODICE	Elementi e materiali	Finiture (V. colori a pag. 95)	Dimensioni
<p>Cod.: 543400041</p> 	<p>Montanti leggeri (Alluminio estruso) Traversa leggera (Legno naturale) Accessori (Inox)</p>	<ul style="list-style-type: none"> • Legno naturale Castagno / Iroko • Alluminio estruso Laccato Sublimato effetto "legno" Anodizzato • Inox Laccato 	
<p>Cod.: 543400042</p> 	<p>Montanti leggeri (Alluminio estruso) Traverse leggere (Legno naturale) Accessori (Inox)</p>	<ul style="list-style-type: none"> • Legno naturale Castagno / Iroko • Alluminio estruso Laccato Sublimato effetto "legno" Anodizzato • Inox Laccato 	
<p>Cod.: 543400043</p> 	<p>Montanti leggeri (Alluminio estruso) Traverse leggere (Legno naturale) Accessori (Inox)</p>	<ul style="list-style-type: none"> • Legno naturale Castagno / Iroko • Alluminio estruso Laccato Sublimato effetto "legno" Anodizzato • Inox Laccato 	

MODELLO E CODICE	Elementi e materiali	Finiture (V. colori a pag. 95)	Dimensioni
<p>Cod.: 540200044</p> 	<p>Montanti leggeri (Alluminio estruso) Traversa leggera (Alluminio estruso) Accessori (Inox)</p> <p>*Fornito senza vetro. Spessore raccomandato 5+5 mm.</p>	<ul style="list-style-type: none"> • Alluminio estruso Laccato Sublimato effetto "legno" Anodizzato • Inox Laccato 	
<p>Cod.: 540200033</p> 	<p>Montanti leggeri (Alluminio estruso) Accessori (Inox)</p> <p>*Fornito senza vetro. Spessore raccomandato 5+5 mm.</p>	<ul style="list-style-type: none"> • Alluminio estruso Laccato Sublimato effetto "legno" Anodizzato • Inox Laccato 	
<p>Cod.: 541100034</p> 	<p>Montanti robusti (Alluminio estruso) Accessori (Inox)</p> <p>*Fornito senza vetro. Spessore raccomandato 5+5 mm.</p>	<ul style="list-style-type: none"> • Alluminio estruso Laccato Sublimato effetto "legno" Anodizzato • Inox Laccato 	
<p>Cod.: 542600035</p> 	<p>Montanti robusti (Alluminio estruso) Traversa leggera (Alluminio estruso) Accessori (Inox)</p> <p>*Fornito senza vetro. Spessore raccomandato 5+5 mm.</p>	<ul style="list-style-type: none"> • Alluminio estruso Laccato Sublimato effetto "legno" Anodizzato • Inox Laccato 	

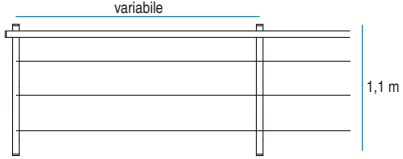
MODELLO E CODICE	Elementi e materiali	Finiture (V. colori a pag. 95)	Dimensioni
Cod.: 540500045 	Montanti leggeri (Alluminio estruso) Traversa leggera (Alluminio estruso) Cavi (Inox) Accessori (Inox)	<ul style="list-style-type: none"> • Alluminio estruso <ul style="list-style-type: none"> Laccato Sublimato effetto "legno" Anodizzato • Inox <ul style="list-style-type: none"> Laccato 	

I modelli di barriera con cavo sono qui rappresentati nella forma standard con cavo singolo. Tutti i modelli possono tuttavia essere fabbricati con cavo doppio (ulteriori informazioni a pag. 94).

Cavo singolo.

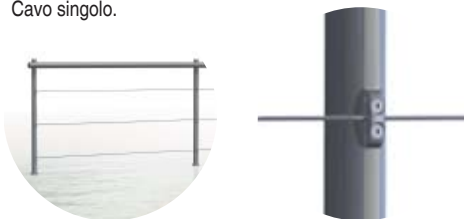

Cavo doppio.

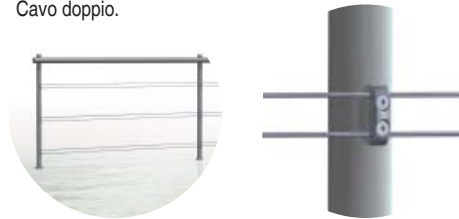

Gamma colori dei pannelli fenolici (cartella colori TRESPA)



etc...

Pannelli fenolici personalizzati



etc...

* I piedi devono essere ancorati ad una base di cemento.

COMPOSIZIONI barriere

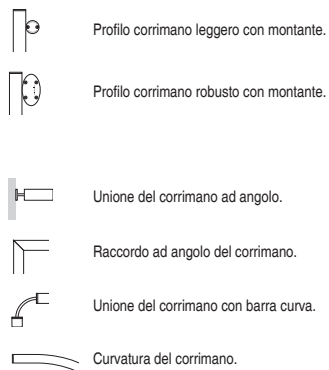
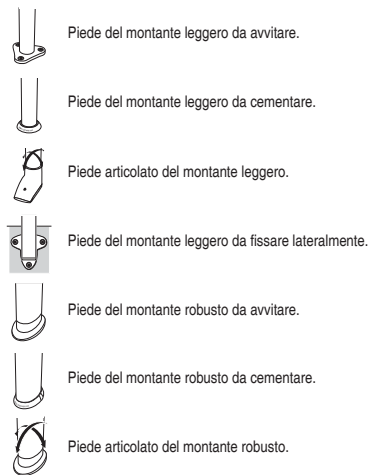
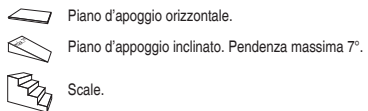

PIANI D'APPOGGIO E MONTANTI

CORRIMANO E TERMINAZIONI

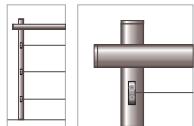
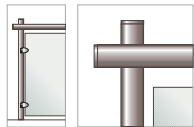
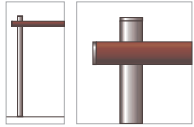
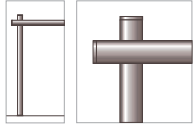

Alluminio + alluminio

Alluminio + legno naturale

Pannelli fenolici o di vetro

Cavi

	<input checked="" type="checkbox"/>	<input checked="" type="checkbox"/>		<input checked="" type="checkbox"/>	<input checked="" type="checkbox"/>	<input checked="" type="checkbox"/>		
		<input checked="" type="checkbox"/>	<input checked="" type="checkbox"/>				<input checked="" type="checkbox"/>	
	<input checked="" type="checkbox"/>	<input checked="" type="checkbox"/>		<input checked="" type="checkbox"/>	<input checked="" type="checkbox"/>	<input checked="" type="checkbox"/>		
	<input checked="" type="checkbox"/>	<input checked="" type="checkbox"/>	<input checked="" type="checkbox"/>		<input checked="" type="checkbox"/>			
		<input checked="" type="checkbox"/>	<input checked="" type="checkbox"/>					
	<input checked="" type="checkbox"/>	<input checked="" type="checkbox"/>	<input checked="" type="checkbox"/>	<input checked="" type="checkbox"/>	<input checked="" type="checkbox"/>			
	<input checked="" type="checkbox"/>	<input checked="" type="checkbox"/>	<input checked="" type="checkbox"/>		<input checked="" type="checkbox"/>			
		<input checked="" type="checkbox"/>	<input checked="" type="checkbox"/>					
	<input checked="" type="checkbox"/>	<input checked="" type="checkbox"/>	<input checked="" type="checkbox"/>	<input checked="" type="checkbox"/>	<input checked="" type="checkbox"/>			

	<input checked="" type="checkbox"/>	<input checked="" type="checkbox"/>	<input checked="" type="checkbox"/>	<input checked="" type="checkbox"/>
	<input checked="" type="checkbox"/>	<input checked="" type="checkbox"/>	<input checked="" type="checkbox"/>	
	<input checked="" type="checkbox"/>		<input checked="" type="checkbox"/>	
	<input checked="" type="checkbox"/>	<input checked="" type="checkbox"/>	<input checked="" type="checkbox"/>	
	<input checked="" type="checkbox"/>	<input checked="" type="checkbox"/>	<input checked="" type="checkbox"/>	
	<input checked="" type="checkbox"/>	<input checked="" type="checkbox"/>	<input checked="" type="checkbox"/>	
	<input checked="" type="checkbox"/>	<input checked="" type="checkbox"/>	<input checked="" type="checkbox"/>	

SCHEMA DI MONTAGGIO
barriere

Fornitura di tutti gli elementi necessari all'installazione del prodotto (viteria, tasselli, chiavi speciali) riuniti e premontati in unità di fornitura. Il prodotto arriva in cantiere pronto per il montaggio.

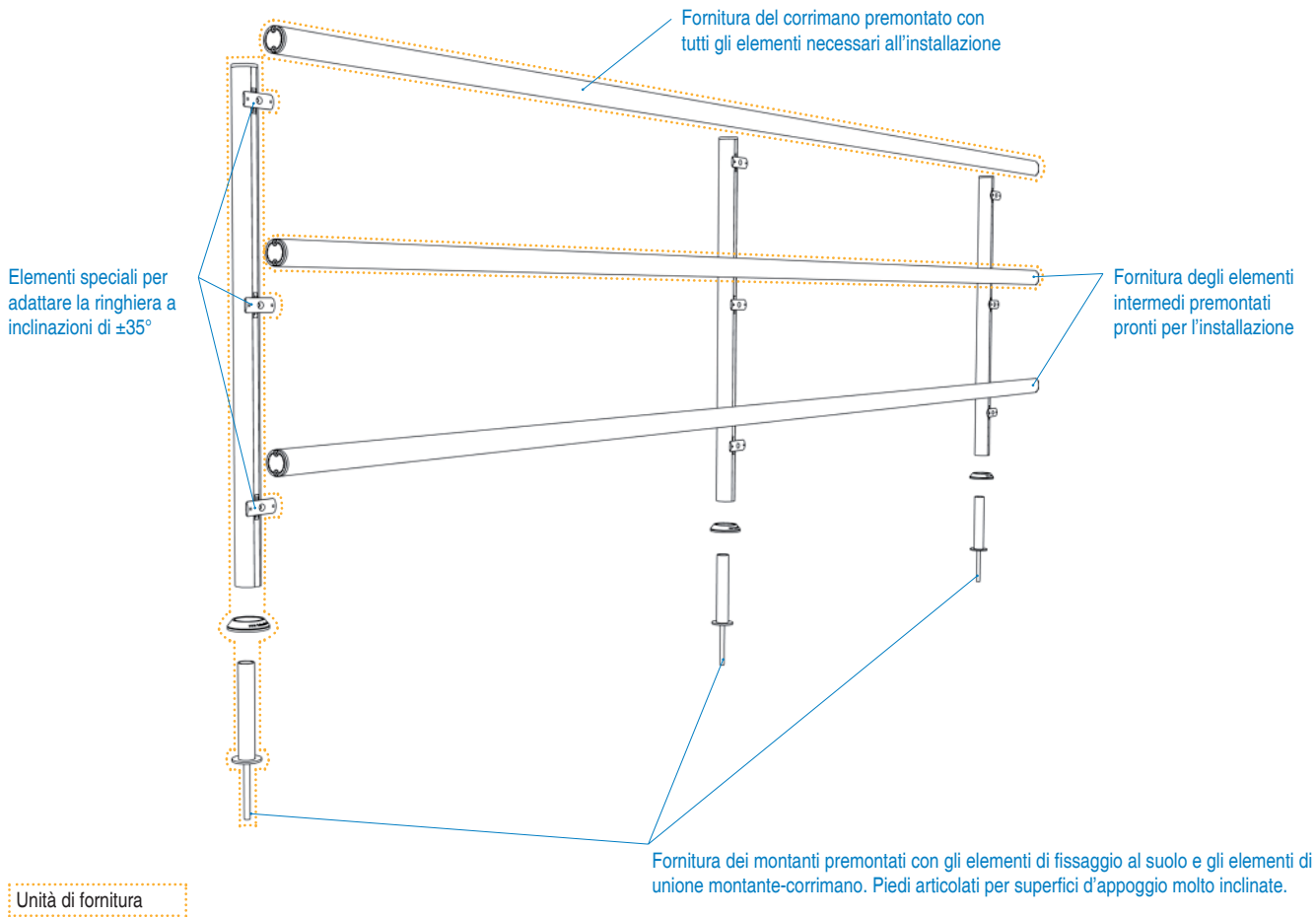



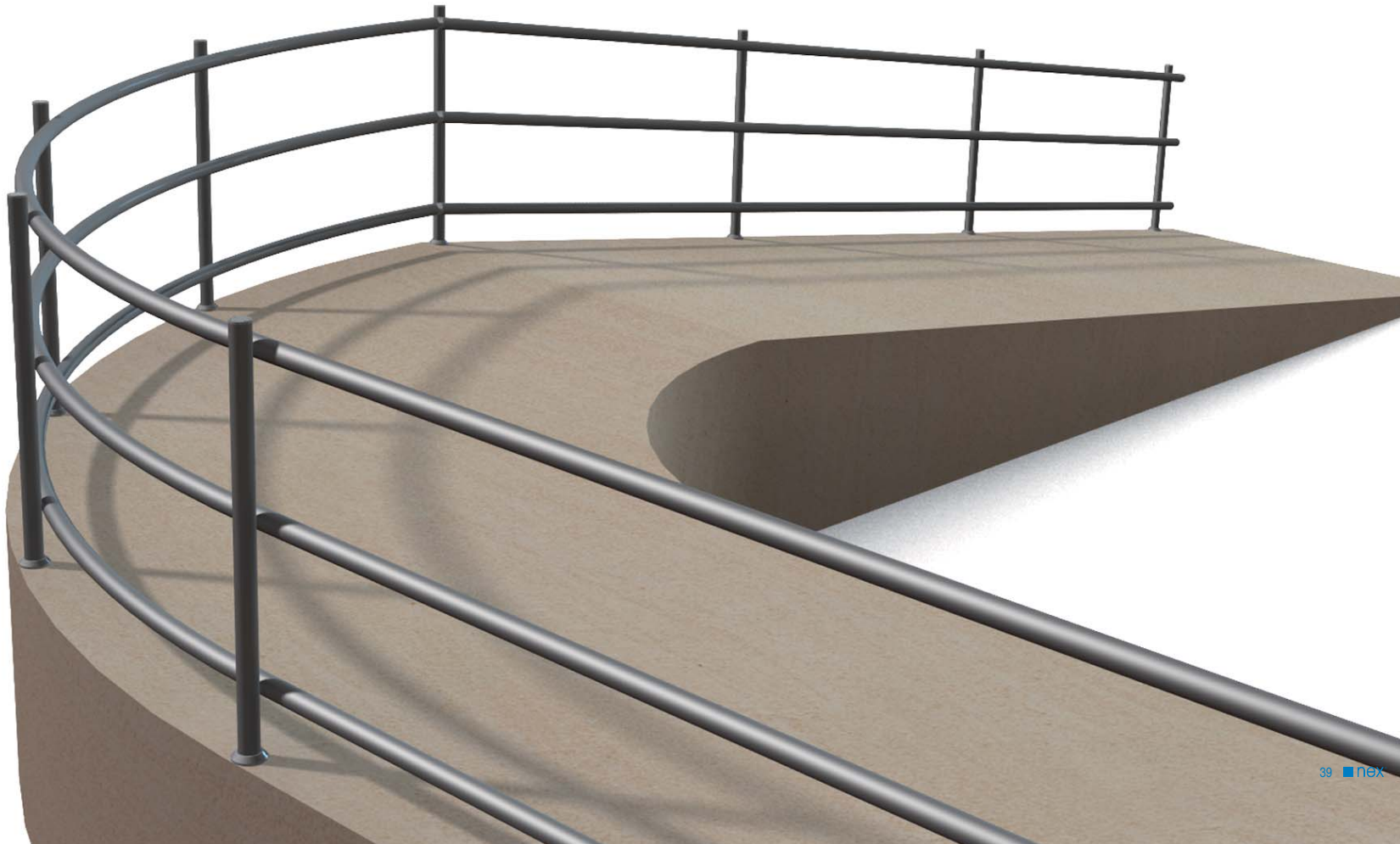

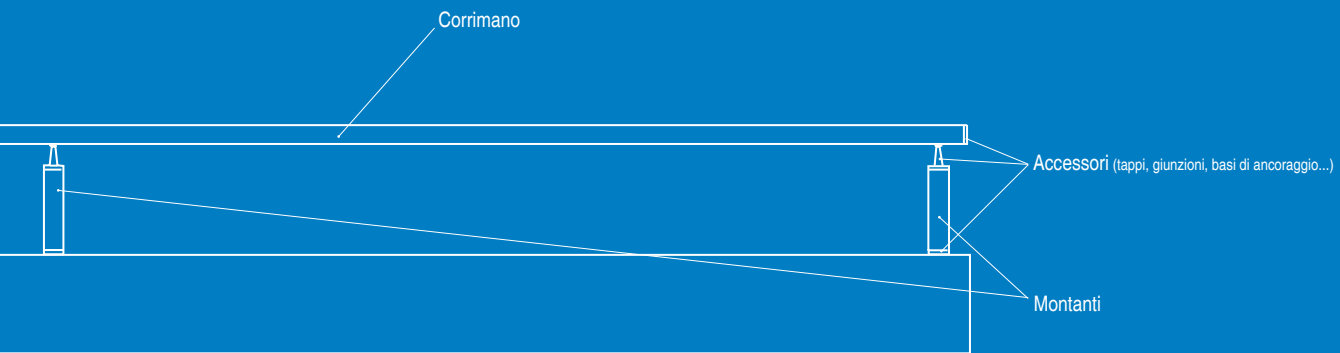

Unità di fornitura

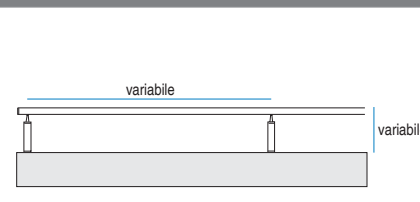

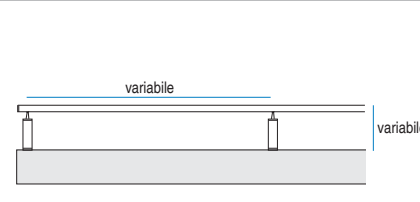

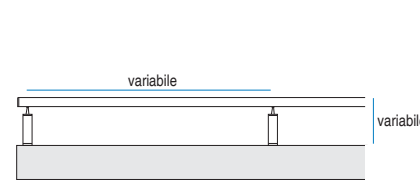



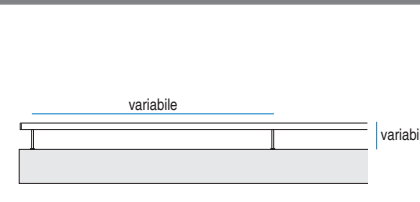

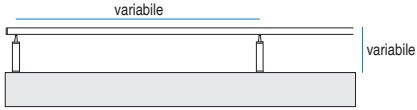

MODELLO E CODICE	Elementi e materiali	Finiture (V. colori a pag. 95)	Dimensioni
<p>Cod.: 54000046</p> 	<p>Corrimano leggero (Alluminio estruso) Montanti leggeri (Alluminio estruso) Accessori (Inox)</p>	<ul style="list-style-type: none"> • Alluminio estruso <ul style="list-style-type: none"> Laccato Sublimato effetto "legno" Anodizzato • Inox <ul style="list-style-type: none"> Laccato 	
<p>Cod.: 54200047</p> 	<p>Corrimano robusto (Alluminio estruso) Montanti leggeri (Alluminio estruso) Accessori (Inox)</p>	<ul style="list-style-type: none"> • Alluminio estruso <ul style="list-style-type: none"> Laccato Sublimato effetto "legno" Anodizzato • Inox <ul style="list-style-type: none"> Laccato 	
<p>Cod.: 54100048</p> 	<p>Corrimano robusto (Alluminio estruso) Montanti robusti (Alluminio estruso) Accessori (Inox)</p>	<ul style="list-style-type: none"> • Alluminio estruso <ul style="list-style-type: none"> Laccato Sublimato effetto "legno" Anodizzato • Inox <ul style="list-style-type: none"> Laccato 	

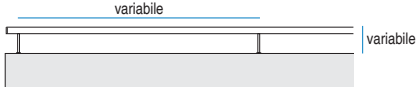
MODELLO E CODICE	Elementi e materiali	Finiture (V. colori a pag. 95)	Dimensioni
<p>Cod.: 54004049</p> 	<p>Corrimano leggero (Alluminio estruso) Barre (Inox) Accessori (Inox)</p>	<ul style="list-style-type: none"> • Alluminio estruso <ul style="list-style-type: none"> Laccato Sublimato effetto "legno" Anodizzato • Inox <ul style="list-style-type: none"> Laccato 	

MODELLO E CODICE	Elementi e materiali	Finiture (V. colori a pag. 95)	Dimensioni
<p>Cod.: 543000050</p> 	<p>Corrimano leggero (Legno naturale) Montanti leggeri (Alluminio estruso) Accessori (Inox)</p>	<ul style="list-style-type: none"> • Legno naturale Castagno / Iroko • Alluminio estruso Laccato Sublimato effetto "legno" Anodizzato • Inox Laccato 	

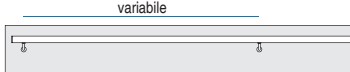
MODELLO E CODICE	Elementi e materiali	Finiture (V. colori a pag. 95)	Dimensioni
<p>Cod.: 545040051</p> 	<p>Corrimano leggero (Legno naturale) Barre (Inox) Accessori (Inox)</p>	<ul style="list-style-type: none"> • Legno naturale Castagno / Iroko • Inox Laccato 	

MODELLO E CODICE	Elementi e materiali	Finiture (V. colori a pag. 95)	Dimensioni
<p>Cod.: 540040081</p> 	<p>Corrimano leggero (Alluminio estruso) Barre (Inox) Accessori (Inox)</p>	<ul style="list-style-type: none"> • Alluminio estruso Laccato Sublimato effetto "legno" Anodizzato • Inox Laccato 	<p>variabile</p> 

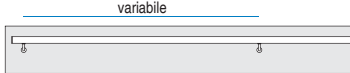
MODELLO E CODICE	Elementi e materiali	Finiture (V. colori a pag. 95)	Dimensioni
<p>Cod.: 545040082</p> 	<p>Corrimano leggero (Legno naturale) Barre (Inox) Accessori (Inox)</p>	<ul style="list-style-type: none"> • Legno naturale Castagno / Iroko • Inox Laccato 	<p>variabile</p> 



* I piedi devono essere ancorati ad una base di cemento.

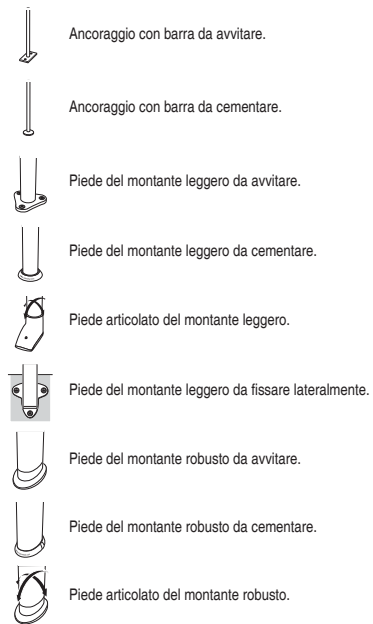
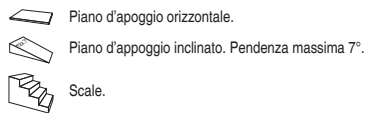

COMPOSIZIONI
corrimano

SCHEMA DI MONTAGGIO - corrimano

Fornitura di tutti gli elementi necessari all'installazione del prodotto (viteria, tasselli, chiavi speciali) riuniti e premontati in unità di fornitura. Il prodotto arriva in cantiere pronto per il montaggio.

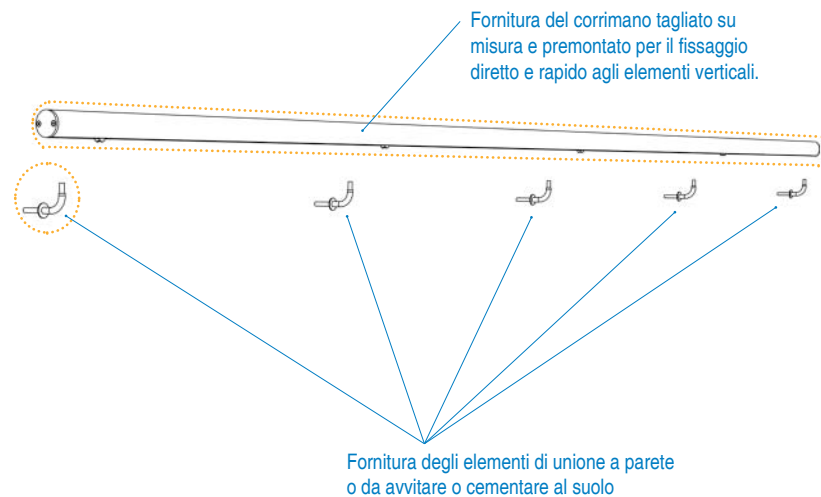

Unità di fornitura



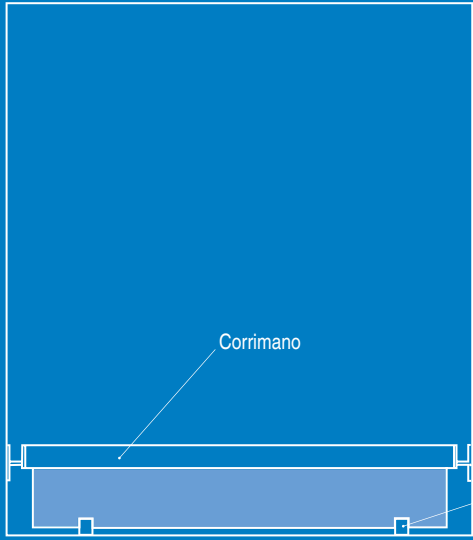







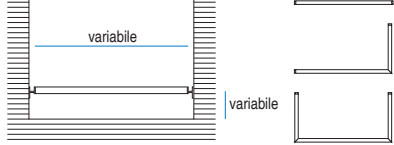

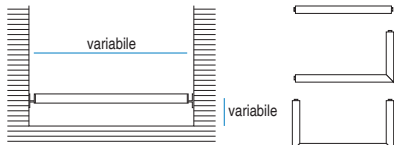
Corrimano

Accessori (tappi, giunzioni, basi di ancoraggio...)

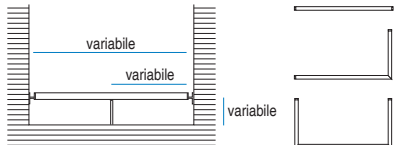

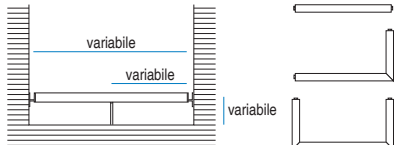
CATALOGO DEI MODELLI
parapetti su muro

MODELLO E CODICE	Elementi e materiali	Finiture (V. colori a pag. 95)	Dimensioni
<p>Cod.: 540050052</p> 	<p>Corrimano leggero (Alluminio estruso) Accessori (Inox)</p>	<ul style="list-style-type: none"> • Alluminio estruso <ul style="list-style-type: none"> Laccato Sublimato effetto "legno" Anodizzato • Inox <ul style="list-style-type: none"> Laccato 	
<p>Cod.: 541050053</p> 	<p>Corrimano robusto (Alluminio estruso) Accessori (Inox)</p>	<ul style="list-style-type: none"> • Alluminio estruso <ul style="list-style-type: none"> Laccato Sublimato effetto "legno" Anodizzato • Inox <ul style="list-style-type: none"> Laccato 	

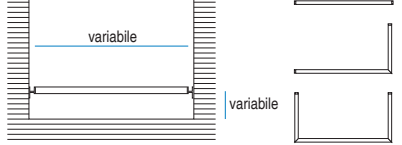
MODELLO E CODICE	Elementi e materiali	Finiture (V. colori a pag. 95)	Dimensioni
<p>Cod.: 540050054</p> 	<p>Corrimano leggero (Alluminio estruso) Barre (Inox) Accessori (Inox)</p>	<ul style="list-style-type: none"> • Alluminio estruso <ul style="list-style-type: none"> Laccato Sublimato effetto "legno" Anodizzato • Inox <ul style="list-style-type: none"> Laccato 	
<p>Cod.: 541050055</p> 	<p>Corrimano robusto (Alluminio estruso) Barre (Inox) Accessori (Inox)</p>	<ul style="list-style-type: none"> • Alluminio estruso <ul style="list-style-type: none"> Laccato Sublimato effetto "legno" Anodizzato • Inox <ul style="list-style-type: none"> Laccato 	

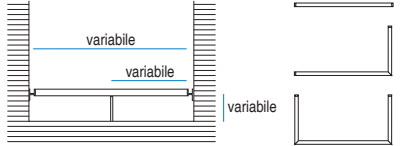
MODELLO E CODICE	Elementi e materiali	Finiture (V. colori a pag. 95)	Dimensioni
<p>Cod.: 545050056</p> 	<p>Corrimano leggero (Legno naturale) Accessori (Inox)</p>	<ul style="list-style-type: none"> • Legno naturale Castagno / Iroko • Inox Laccato 	

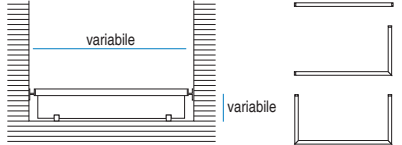
MODELLO E CODICE	Elementi e materiali	Finiture (V. colori a pag. 95)	Dimensioni
<p>Cod.: 545050057</p> 	<p>Corrimano leggero (Legno naturale) Barre (Inox) Accessori (Inox)</p>	<ul style="list-style-type: none"> • Legno naturale Castagno / Iroko • Inox Laccato 	

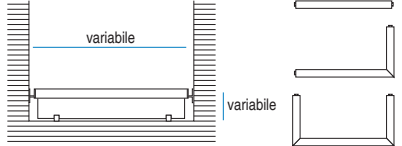
MODELLO E CODICE	Elementi e materiali	Finiture (V. colori a pag. 95)	Dimensioni
<p>Cod.: 540150058</p> 	<p>Corrimano leggero (Alluminio estruso) Accessori (Inox)</p> <p>*Fornito senza vetro. Spessore raccomandato 5+5 mm.</p>	<ul style="list-style-type: none"> • Alluminio estruso Laccato Sublimato effetto "legno" Anodizzato • Inox Laccato 	
<p>Cod.: 541150059</p> 	<p>Corrimano robusto (Alluminio estruso) Accessori (Inox)</p> <p>*Fornito senza vetro. Spessore raccomandato 5+5 mm.</p>	<ul style="list-style-type: none"> • Alluminio estruso Laccato Sublimato effetto "legno" Anodizzato • Inox Laccato 	

Gamma colori dei pannelli fenolici (cartella colori TRESPA)



Pannelli fenolici personalizzati



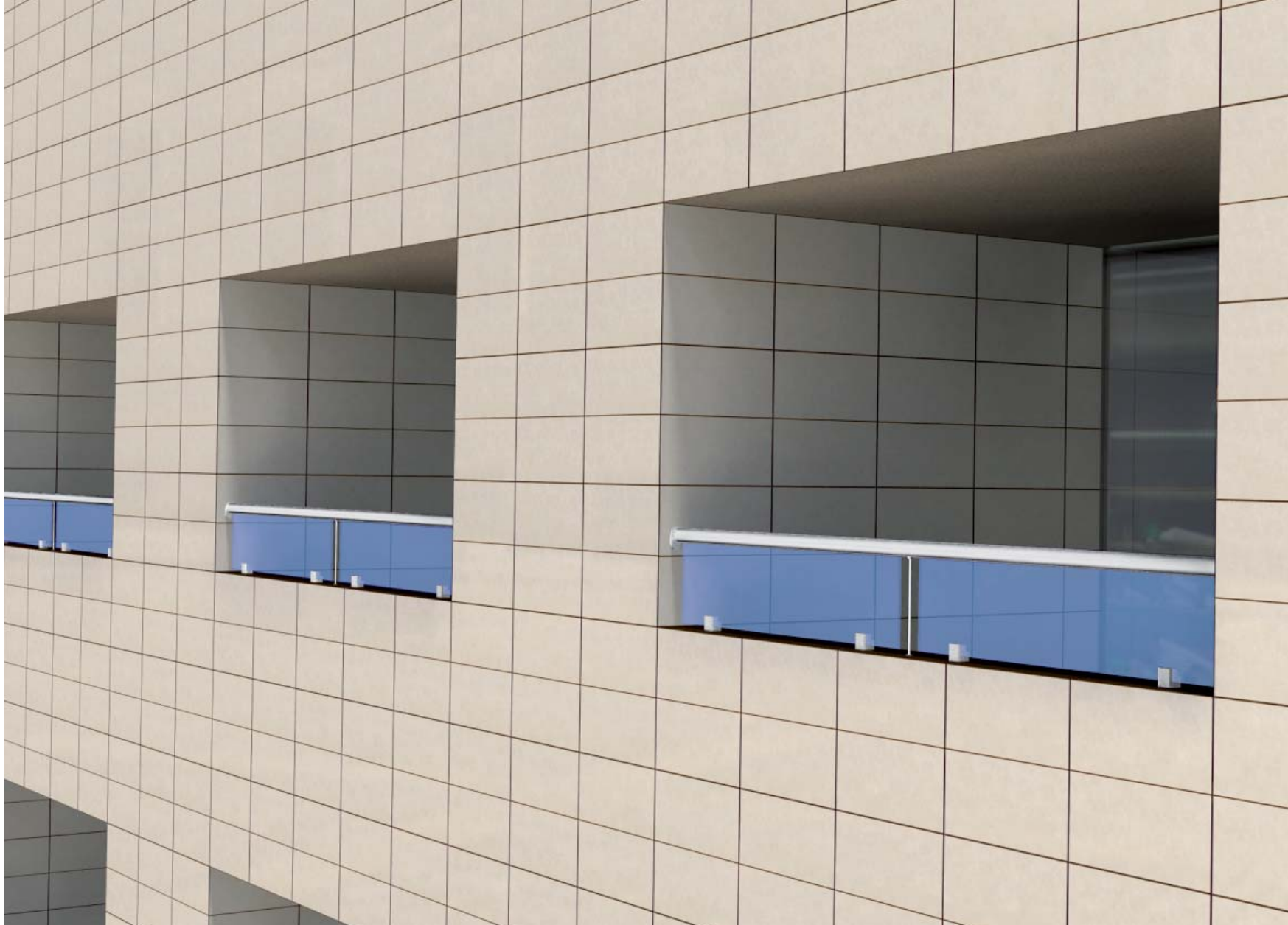

* I piedi devono essere ancorati ad una base di cemento.



Profilo corrimano leggero con montante.



Profilo corrimano robusto con montante.



Profilo del corrimano leggero con barra.



Profilo del corrimano robusto con barra.



Unione del corrimano ad angolo.



Raccordo ad angolo del corrimano.











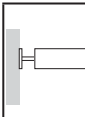
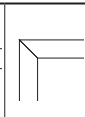
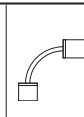
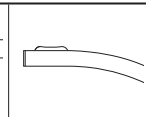
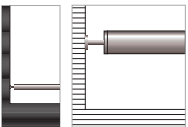

Unione del corrimano con barra curva.

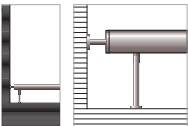

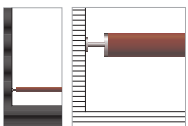
Curvatura del corrimano.

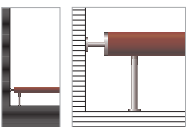
COMPOSIZIONI parapeetti su muro

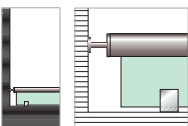
CORRIMANO E TERMINAZIONI

					
	Alluminio		<input checked="" type="checkbox"/>	<input checked="" type="checkbox"/>	<input checked="" type="checkbox"/>
		<input checked="" type="checkbox"/>	<input checked="" type="checkbox"/>	<input checked="" type="checkbox"/>	
	Inox + alluminio		<input checked="" type="checkbox"/>	<input checked="" type="checkbox"/>	<input checked="" type="checkbox"/>
		<input checked="" type="checkbox"/>	<input checked="" type="checkbox"/>	<input checked="" type="checkbox"/>	
	Legno naturale		<input checked="" type="checkbox"/>	<input checked="" type="checkbox"/>	
					
	Acciaio inox + legno naturale		<input checked="" type="checkbox"/>	<input checked="" type="checkbox"/>	
					
	Pannelli fenolici o di vetro		<input checked="" type="checkbox"/>	<input checked="" type="checkbox"/>	<input checked="" type="checkbox"/>
		<input checked="" type="checkbox"/>	<input checked="" type="checkbox"/>	<input checked="" type="checkbox"/>	

SCHEMA DI MONTAGGIO parapetti su muro

Fornitura di tutti gli elementi necessari all'installazione del prodotto (viteria, tasselli, chiavi speciali) riuniti e premontati in unità di fornitura. Il prodotto arriva in cantiere pronto per il montaggio.

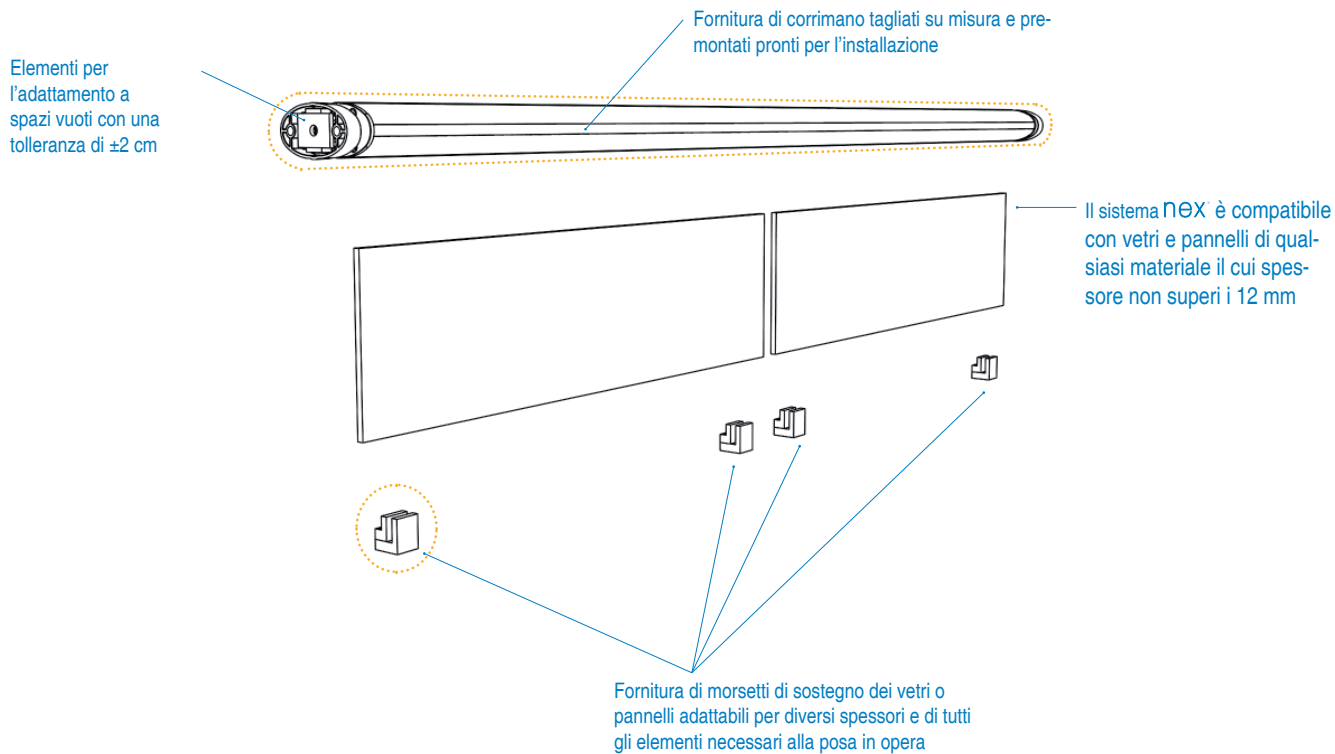



Unità di fornitura

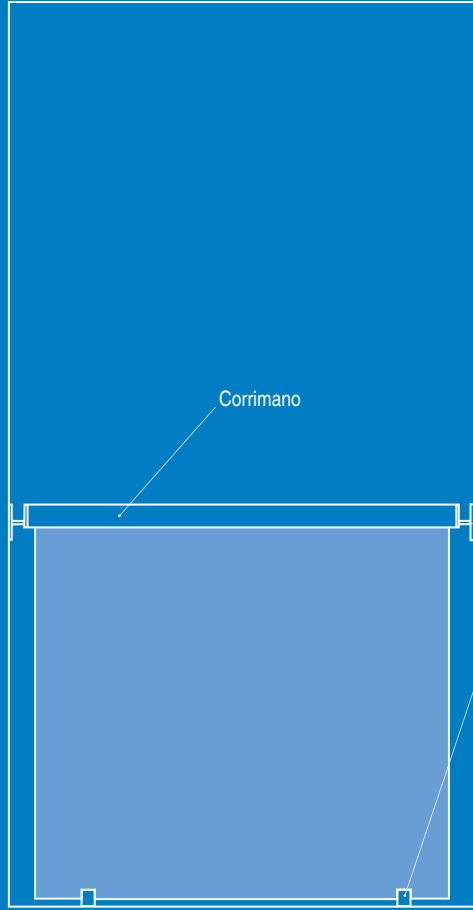





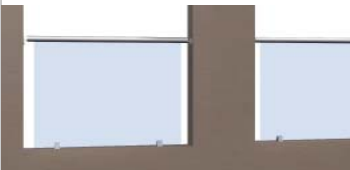
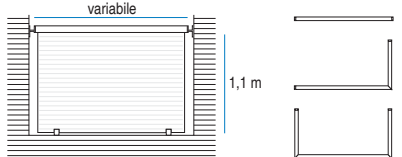

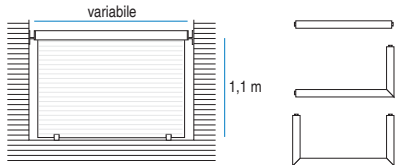
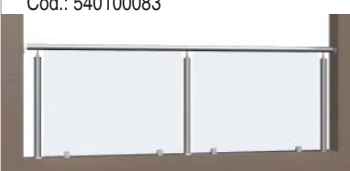
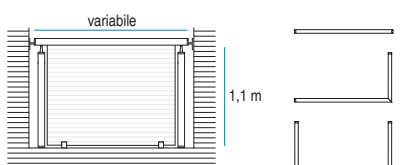
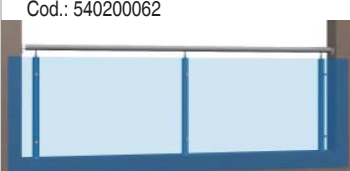
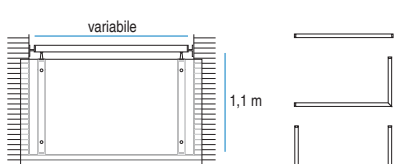
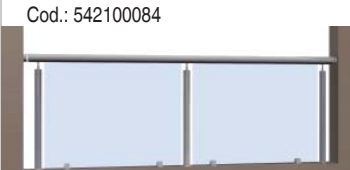
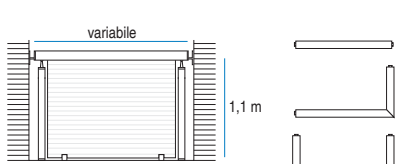
CATALOGO DEI MODELLI

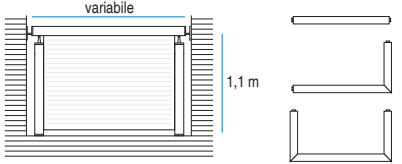
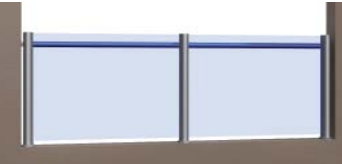
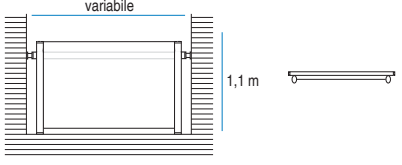
parapetti per balconi

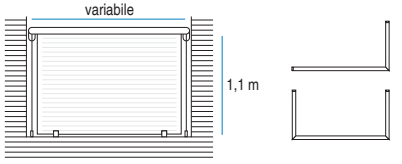
MODELLO E CODICE	Elementi e materiali	Finiture (V. colori a pag. 95)	Dimensioni
<p>Cod.: 540150060</p> 	<p>Corrimano leggero (Alluminio estruso) Accessori (Inox)</p> <p>*Fornito senza vetro. Spessore raccomandato 5+5 mm.</p>	<ul style="list-style-type: none"> • Alluminio estruso <ul style="list-style-type: none"> Laccato Sublimato effetto "legno" Anodizzato • Inox <ul style="list-style-type: none"> Laccato 	
<p>Cod.: 541150061</p> 	<p>Corrimano robusto (Alluminio estruso) Accessori (Inox)</p> <p>*Fornito senza vetro. Spessore raccomandato 5+5 mm.</p>	<ul style="list-style-type: none"> • Alluminio estruso <ul style="list-style-type: none"> Laccato Sublimato effetto "legno" Anodizzato • Inox <ul style="list-style-type: none"> Laccato 	
<p>Cod.: 540100083</p> 	<p>Corrimano leggero (Alluminio estruso) Montanto leggeri (Alluminio estruso) Accessori (Inox)</p> <p>*Fornito senza vetro. Spessore raccomandato 5+5 mm.</p>	<ul style="list-style-type: none"> • Alluminio estruso <ul style="list-style-type: none"> Laccato Sublimato effetto "legno" Anodizzato • Inox <ul style="list-style-type: none"> Laccato 	
<p>Cod.: 540200062</p> 	<p>Corrimano leggero (Alluminio estruso) Montanto leggeri (Alluminio estruso) Accessori (Inox)</p> <p>*Fornito senza vetro. Spessore raccomandato 5+5 mm.</p>	<ul style="list-style-type: none"> • Alluminio estruso <ul style="list-style-type: none"> Laccato Sublimato effetto "legno" Anodizzato • Inox <ul style="list-style-type: none"> Laccato 	
<p>Cod.: 542100084</p> 	<p>Corrimano robusto (Alluminio estruso) Montanto leggeri (Alluminio estruso) Accessori (Inox)</p> <p>*Fornito senza vetro. Spessore raccomandato 5+5 mm.</p>	<ul style="list-style-type: none"> • Alluminio estruso <ul style="list-style-type: none"> Laccato Sublimato effetto "legno" Anodizzato • Inox <ul style="list-style-type: none"> Laccato 	

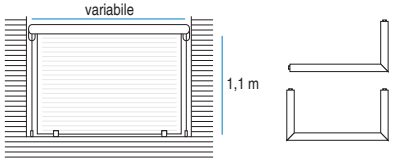
MODELLO E CODICE	Elementi e materiali	Finiture (V. colori a pag. 95)	Dimensioni
<p>Cod.: 541100085</p> 	<p>Corrimano robusto (Alluminio estruso) Montanti robusti (Alluminio estruso) Accessori (Inox)</p> <p>*Fornito senza vetro. Spessore raccomandato 5+5 mm.</p>	<ul style="list-style-type: none"> • Alluminio estruso Laccato Sublimato effetto "legno" Anodizzato • Inox Laccato 	
<p>Cod.: 542600086</p> 	<p>Montanti robusti (Alluminio estruso) Traversa leggera (Alluminio estruso) Accessori (Inox)</p> <p>*Fornito senza vetro. Spessore raccomandato 5+5 mm.</p>	<ul style="list-style-type: none"> • Alluminio estruso Laccato Sublimato effetto "legno" Anodizzato • Inox Laccato 	
<p>Cod.: 540150087</p> 	<p>Corrimano semplice (Alluminio estruso) Cavo tensore (Inox) Accessori (Inox)</p> <p>*Fornito senza vetro. Spessore raccomandato 5+5 mm.</p>	<ul style="list-style-type: none"> • Alluminio estruso Laccato Sublimato effetto "legno" Anodizzato • Inox Laccato 	
<p>Cod.: 541150088</p> 	<p>Corrimano robusto (Alluminio estruso) Cavo tensore (Inox) Accessori (Inox)</p> <p>*Fornito senza vetro. Spessore raccomandato 5+5 mm.</p>	<ul style="list-style-type: none"> • Alluminio estruso Laccato Sublimato effetto "legno" Anodizzato • Inox Laccato 	

Gamma colori dei pannelli fenolici (cartella colori TRESPA)

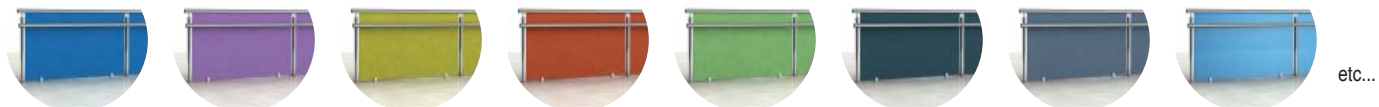

Pannelli fenolici personalizzati





* I piedi devono essere ancorati ad una base di cemento.



Profilo corrimano leggero con montante.



Profilo corrimano robusto con montante.



Profilo del corrimano leggero con barra.



Profilo del corrimano robusto con barra.



Unione del corrimano ad angolo.



Raccordo ad angolo del corrimano.



Unione del corrimano con barra curva.



Curvatura del corrimano.

COMPOSIZIONI parapetti per balconi

PIANI D'APPOGGIO E MONTANTI

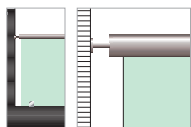

Pannelli fenolici
o di vetro

	■	■			■	■	
			■				■
	■	■			■	■	

CORRIMANO E TERMINAZIONI

	■	■	■	■
	■	■	■	



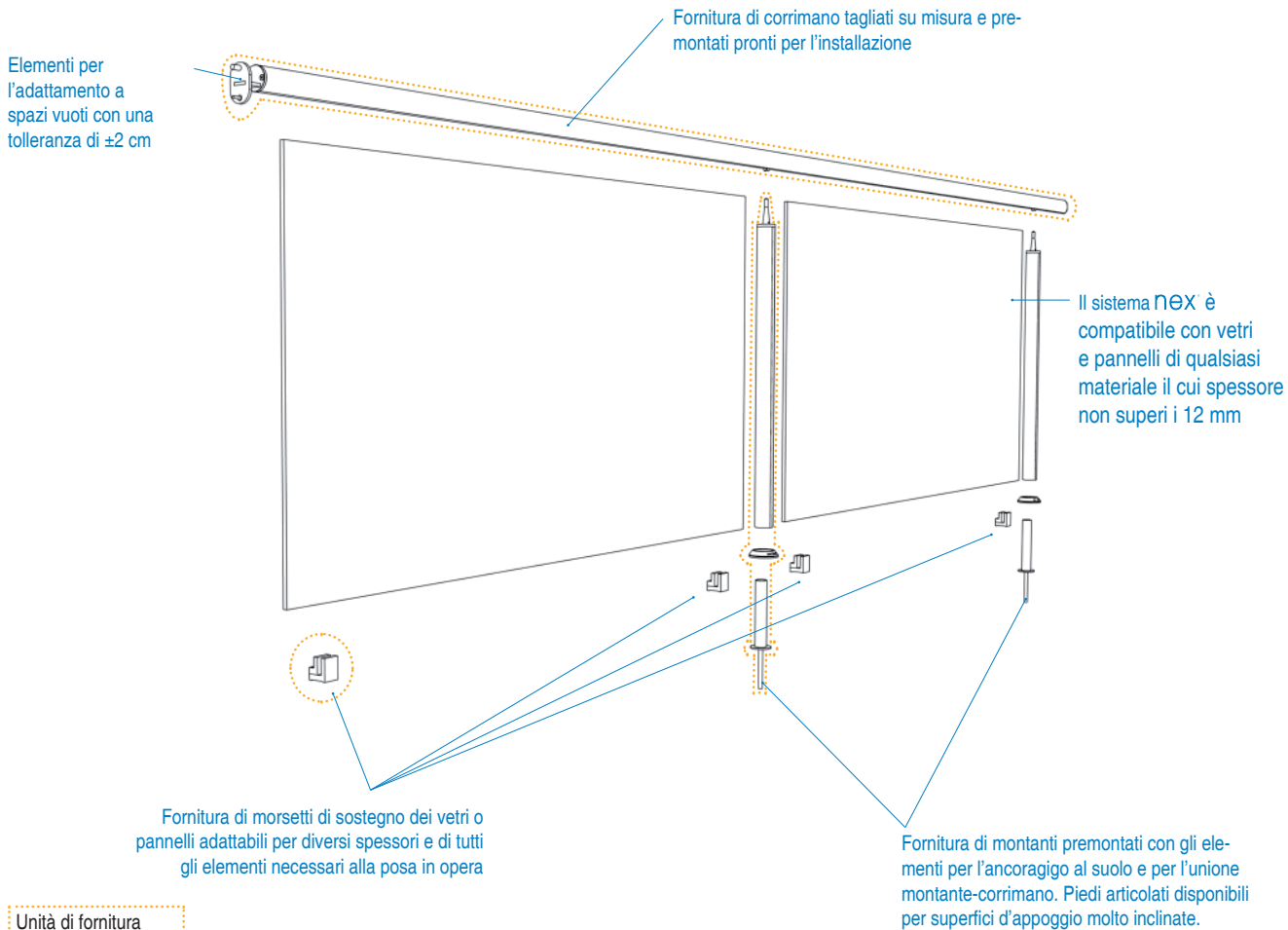

SCHEMA DI MONTAGGIO parapetti per balconi

Fornitura di tutti gli elementi necessari all'installazione del prodotto (viteria, tasselli, chiavi speciali) riuniti e premontati in unità di fornitura. Il prodotto arriva in cantiere pronto per il montaggio.

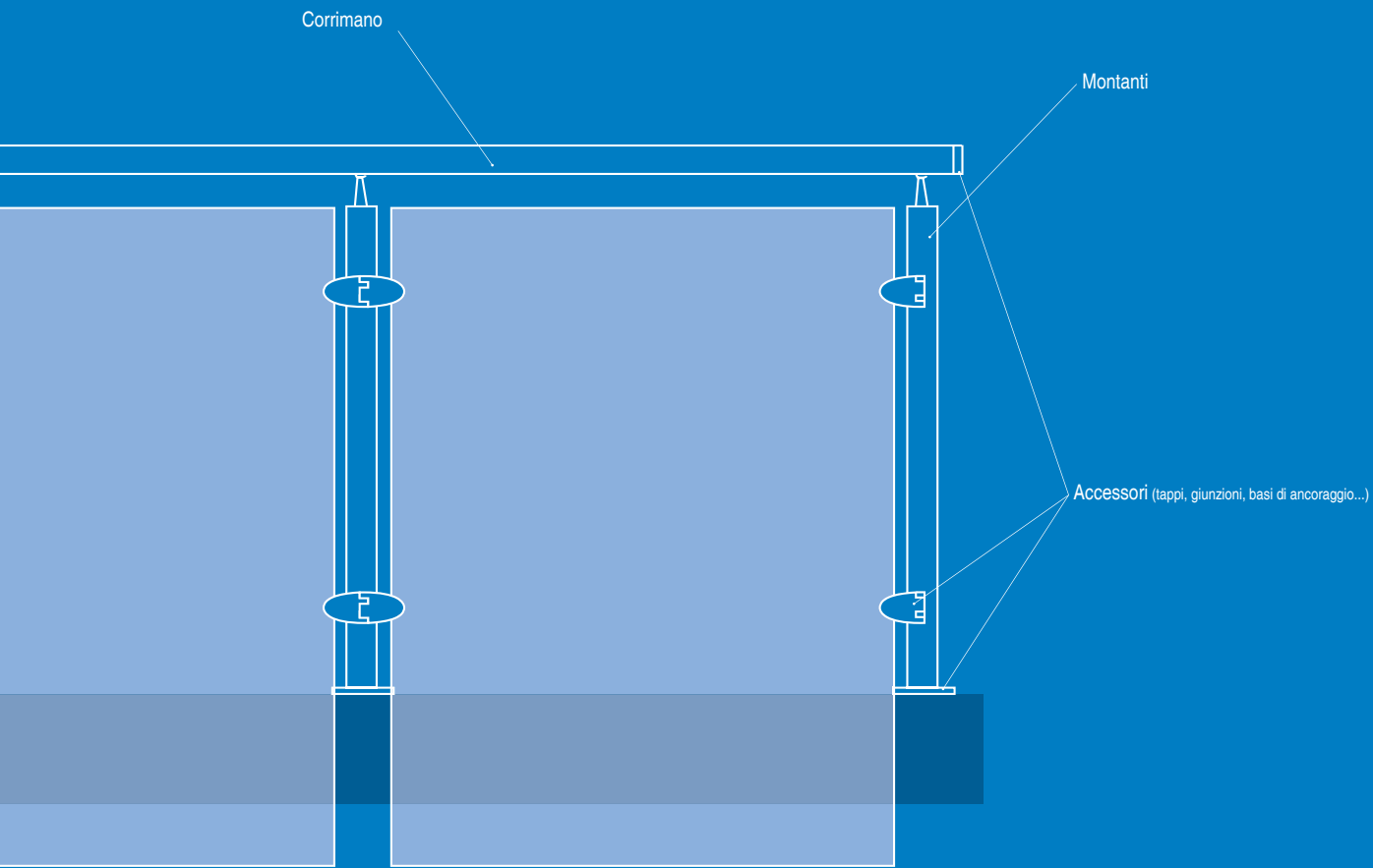

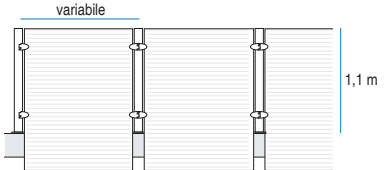

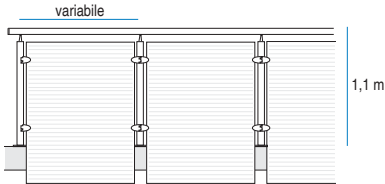

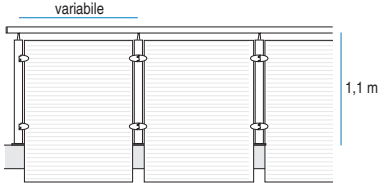
MODELLO E CODICE	Elementi e materiali	Finiture (V. colori a pag. 95)	Dimensioni
<p>Cod.: 541200074</p> 	<p>Montanti robusti (Alluminio estruso) Accessori (Inox)</p> <p>*Fornito senza vetro. Spessore raccomandato 5+5 mm.</p>	<ul style="list-style-type: none"> • Alluminio estruso <ul style="list-style-type: none"> Laccato Sublimato effetto "legno" Anodizzato • Inox <ul style="list-style-type: none"> Laccato 	
<p>Cod.: 540200076</p> 	<p>Corrimano leggero (Alluminio estruso) Montanti leggeri (Alluminio estruso) Accessori (Inox)</p> <p>*Fornito senza vetro. Spessore raccomandato 5+5 mm.</p>	<ul style="list-style-type: none"> • Alluminio estruso <ul style="list-style-type: none"> Laccato Sublimato effetto "legno" Anodizzato • Inox <ul style="list-style-type: none"> Laccato 	
<p>Cod.: 542200078</p> 	<p>Corrimano leggero (Alluminio estruso) Montanti robusti (Alluminio estruso) Accessori (Inox)</p> <p>*Fornito senza vetro. Spessore raccomandato 5+5 mm.</p>	<ul style="list-style-type: none"> • Alluminio estruso <ul style="list-style-type: none"> Laccato Sublimato effetto "legno" Anodizzato • Inox <ul style="list-style-type: none"> Laccato 	

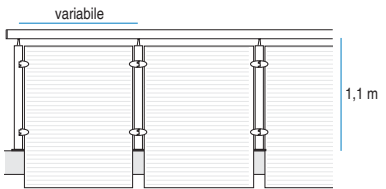
MODELLO E CODICE	Elementi e materiali	Finiture (V. colori a pag. 95)	Dimensioni
<p>Cod.: 541200080</p> 	<p>Corrimano robusto (Alluminio estruso) Montanti robusti (Alluminio estruso) Accessori (Inox)</p> <p>*Fornito senza vetro. Spessore raccomandato 5+5 mm.</p>	<ul style="list-style-type: none"> · Alluminio estruso <ul style="list-style-type: none"> Laccato Sublimato effetto "legno" Anodizzato · Inox <ul style="list-style-type: none"> Laccato 	

Gamma colori dei pannelli fenolici (cartella colori TRESPA)

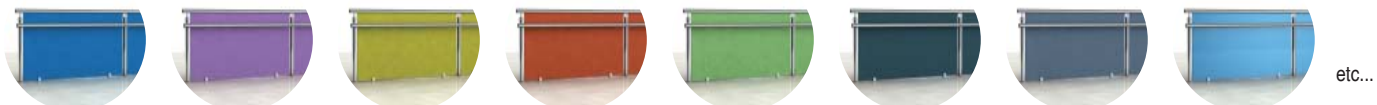

Pannelli fenolici personalizzati



* I piedi devono essere ancorati ad una base di cemento.

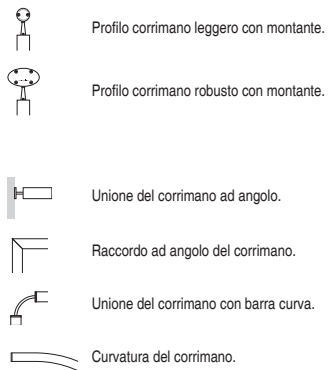
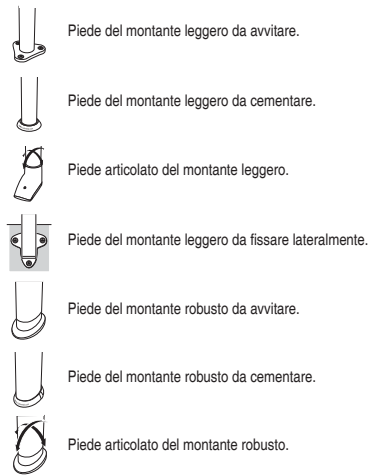
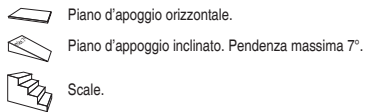

COMPOSIZIONI
ringhiera con pannelli esterni alla soletta

PIANI D'APPOGGIO E MONTANTI

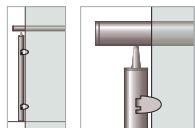

Pannelli fenolici o di vetro

	■	■			■	■	
			■				■
	■	■			■	■	

CORRIMANO E TERMINAZIONI

	■	■	■	
	■	■	■	

SCHEMA DI MONTAGGIO
ringhiera con pannelli esterni alla soletta

Fornitura di tutti gli elementi necessari all'installazione del prodotto (viteria, tasselli, chiavi speciali) riuniti e premontati in unità di fornitura. Il prodotto arriva in cantiere pronto per il montaggio.

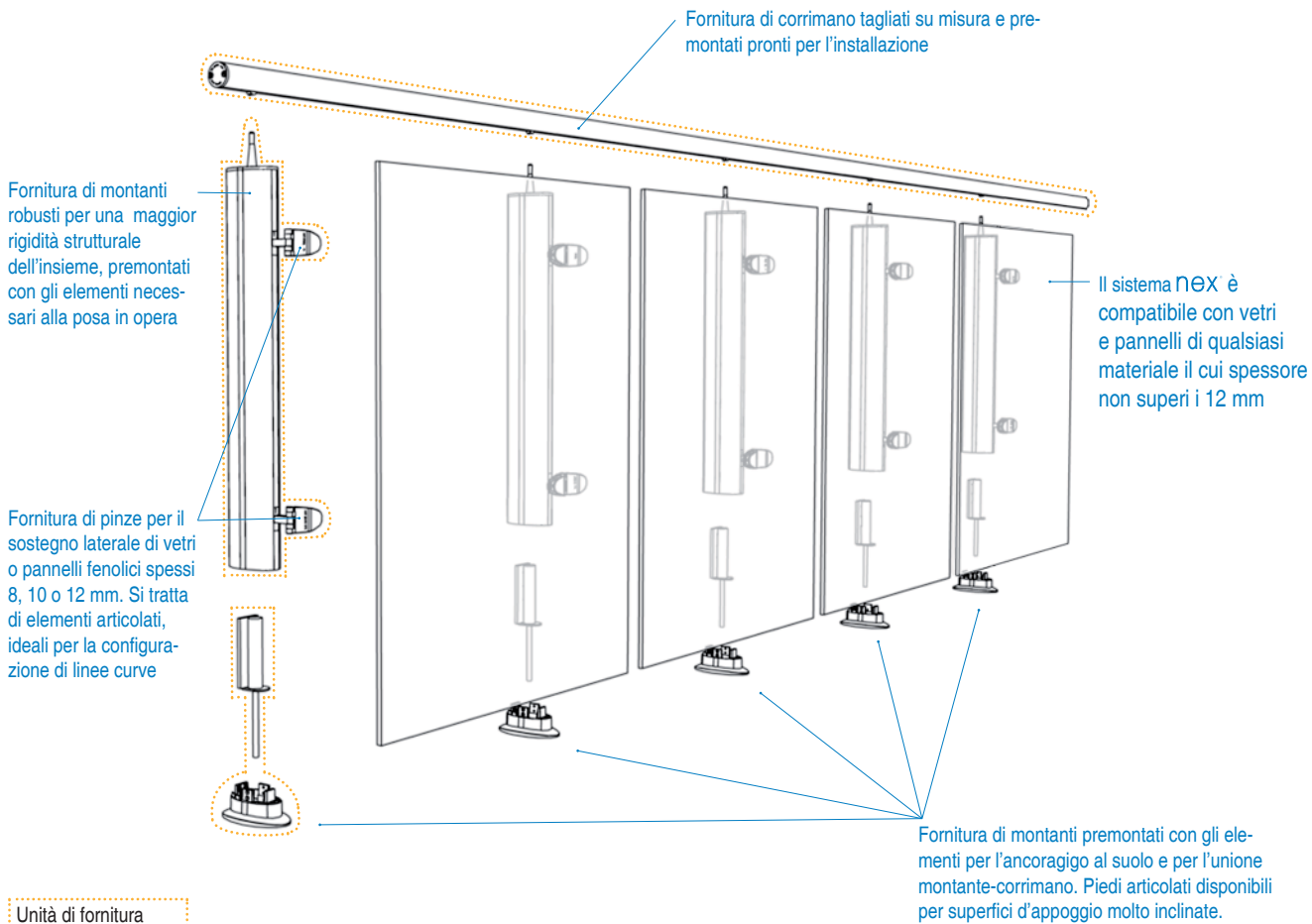



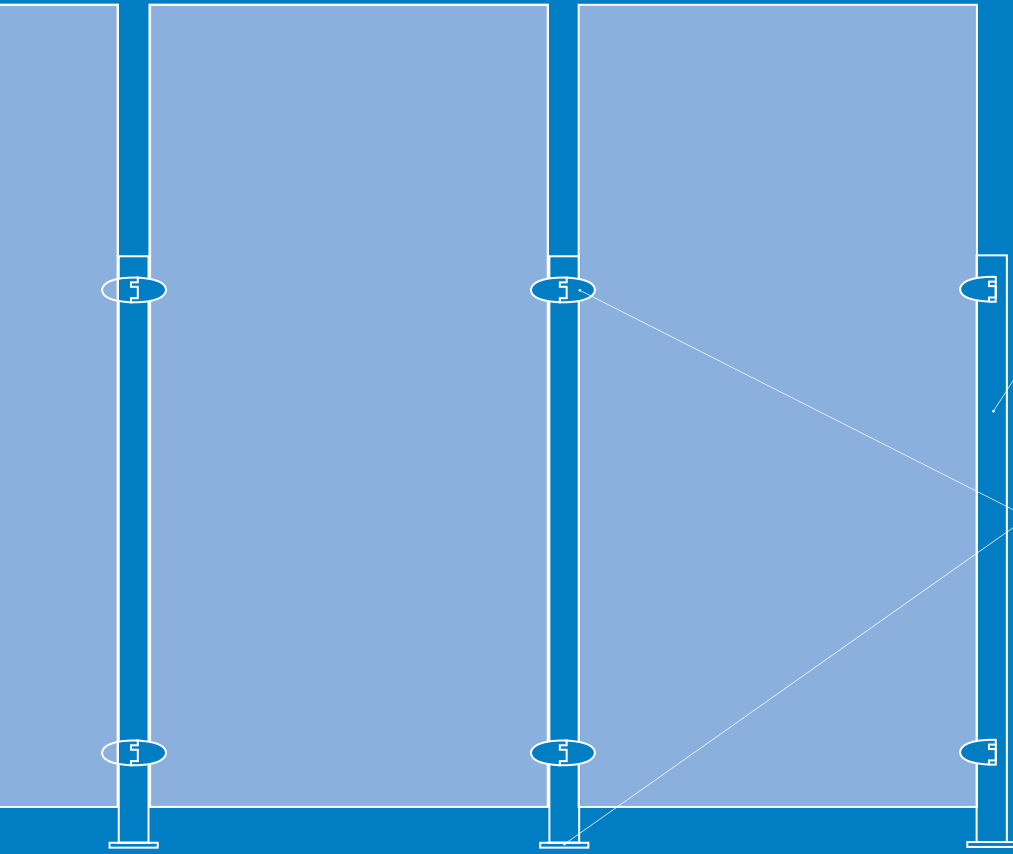









Montanti

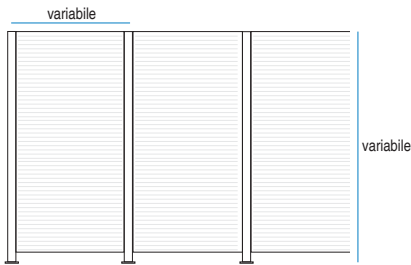

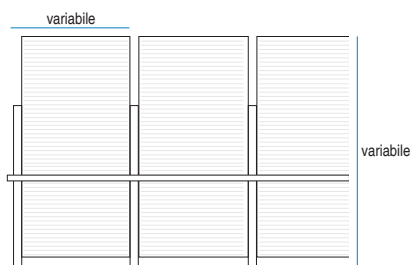

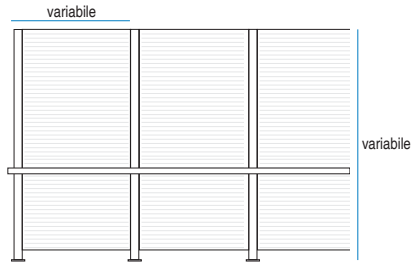
Accessori (tappi, giunzioni, basi di ancoraggio...)

CATALOGO DEI MODELLI
pareti divisorie

MODELLO E CODICE	Elementi e materiali	Finiture (V. colori a pag. 95)	Dimensioni
<p>Cod.: 541200063</p> 	<p>Montanti robusti (Alluminio estruso) Accessori (Inox)</p> <p>*Fornito senza vetro. Spessore raccomandato 5+5 mm.</p>	<ul style="list-style-type: none"> • Alluminio estruso Laccato Sublimato effetto "legno" Anodizzato • Inox Laccato 	
<p>Cod.: 541200064</p> 	<p>Montanti robusti (Alluminio estruso) Accessori (Inox)</p> <p>*Fornito senza vetro. Spessore raccomandato 5+5 mm.</p>	<ul style="list-style-type: none"> • Alluminio estruso Laccato Sublimato effetto "legno" Anodizzato • Inox Laccato 	
<p>Cod.: 541100065</p> 	<p>Montanti robusti (Alluminio estruso) Accessori (Inox)</p> <p>*Fornito senza vetro. Spessore raccomandato 5+5 mm.</p>	<ul style="list-style-type: none"> • Alluminio estruso Laccato Sublimato effetto "legno" Anodizzato • Inox Laccato 	

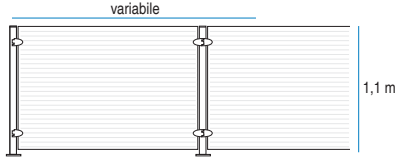
MODELLO E CODICE	Elementi e materiali	Finiture (V. colori a pag. 95)	Dimensioni
<p>Cod.: 541100066</p> 	<p>Montanti robusti (Alluminio estruso) Accessori (Inox)</p> <p>*Fornito senza vetro. Spessore raccomandato 5+5 mm.</p>	<ul style="list-style-type: none"> • Alluminio estruso <ul style="list-style-type: none"> Laccato Sublimato effetto "legno" Anodizzato • Inox <ul style="list-style-type: none"> Laccato 	
<p>Cod.: 542400067</p> 	<p>Montanti robusti (Alluminio estruso) Traversa leggera (Alluminio estruso) Accessori (Inox)</p> <p>*Fornito senza vetro. Spessore raccomandato 5+5 mm.</p>	<ul style="list-style-type: none"> • Alluminio estruso <ul style="list-style-type: none"> Laccato Sublimato effetto "legno" Anodizzato • Inox <ul style="list-style-type: none"> Laccato 	
<p>Cod.: 542400068</p> 	<p>Montanti robusti (Alluminio estruso) Traversa leggera (Alluminio estruso) Accessori (Inox)</p> <p>*Fornito senza vetro. Spessore raccomandato 5+5 mm.</p>	<ul style="list-style-type: none"> • Alluminio estruso <ul style="list-style-type: none"> Laccato Sublimato effetto "legno" Anodizzato • Inox <ul style="list-style-type: none"> Laccato 	

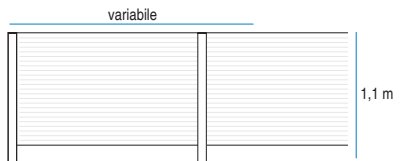
MODELLO E CODICE	Elementi e materiali	Finiture (V. colori a pag. 95)	Dimensioni
<p>Cod.: 54020069</p> 	<p>Montanti leggeri (Alluminio estruso) Accessori (Inox)</p> <p>*Fornito senza vetro. Spessore raccomandato 5+5 mm.</p>	<ul style="list-style-type: none"> • Alluminio estruso <ul style="list-style-type: none"> Laccato Sublimato effetto "legno" Anodizzato • Inox <ul style="list-style-type: none"> Laccato 	
<p>Cod.: 54120070</p> 	<p>Montanti robusti (Alluminio estruso) Accessori (Inox)</p> <p>*Fornito senza vetro. Spessore raccomandato 5+5 mm.</p>	<ul style="list-style-type: none"> • Alluminio estruso <ul style="list-style-type: none"> Laccato Sublimato effetto "legno" Anodizzato • Inox <ul style="list-style-type: none"> Laccato 	
<p>Cod.: 54110071</p> 	<p>Montanti robusti (Alluminio estruso) Accessori (Inox)</p> <p>*Fornito senza vetro. Spessore raccomandato 5+5 mm.</p>	<ul style="list-style-type: none"> • Alluminio estruso <ul style="list-style-type: none"> Laccato Sublimato effetto "legno" Anodizzato • Inox <ul style="list-style-type: none"> Laccato 	

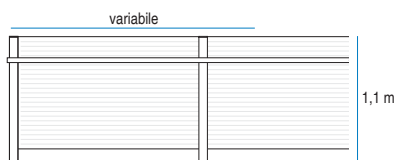
MODELLO E CODICE	Elementi e materiali	Finiture (V. colori a pag. 95)	Dimensioni
Cod.: 540200033 	Montanti leggeri (Alluminio estruso) Accessori (Inox) *Fornito senza vetro. Spessore raccomandato 5+5 mm.	<ul style="list-style-type: none"> • Alluminio estruso Laccato Sublimato effetto "legno" Anodizzato • Inox Laccato 	
Cod.: 541100034 	Montanti robusti (Alluminio estruso) Accessori (Inox) *Fornito senza vetro. Spessore raccomandato 5+5 mm.	<ul style="list-style-type: none"> • Alluminio estruso Laccato Sublimato effetto "legno" Anodizzato • Inox Laccato 	
Cod.: 542600035 	Montanti robusti (Alluminio estruso) Traversa leggera (Alluminio estruso) Accessori (Inox) *Fornito senza vetro. Spessore raccomandato 5+5 mm.	<ul style="list-style-type: none"> • Alluminio estruso Laccato Sublimato effetto "legno" Anodizzato • Inox Laccato 	

Gamma colori dei pannelli fenolici (cartella colori TRESPA)



Pannelli fenolici personalizzati



* I piedi devono essere ancorati ad una base di cemento.

 Piano d'appoggio orizzontale.

 Piano d'appoggio inclinato. Pendenza massima 7°.

 Scale.

 Piede del montante leggero da avvitare.

 Piede del montante leggero da cementare.

 Piede articolato del montante leggero.

 Piede del montante leggero da fissare lateralmente.

 Piede del montante robusto da avvitare.

 Piede del montante robusto da cementare.

 Piede articolato del montante robusto.

COMPOSIZIONI
pareti divisorie

PIANI D'APPOGGIO E MONTANTI

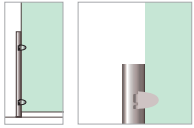
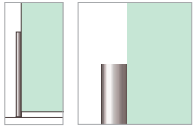

Pannelli fenici o di vetro

Pannelli fenici o di vetro

					■	■	
							■
					■	■	
	■	■			■	■	
			■				■
	■	■			■	■	

SCHEMA DI MONTAGGIO pareti divisorie

Fornitura di tutti gli elementi necessari all'installazione del prodotto (viteria, tasselli, chiavi speciali) riuniti e premontati in unità di fornitura. Il prodotto arriva in cantiere pronto per il montaggio.

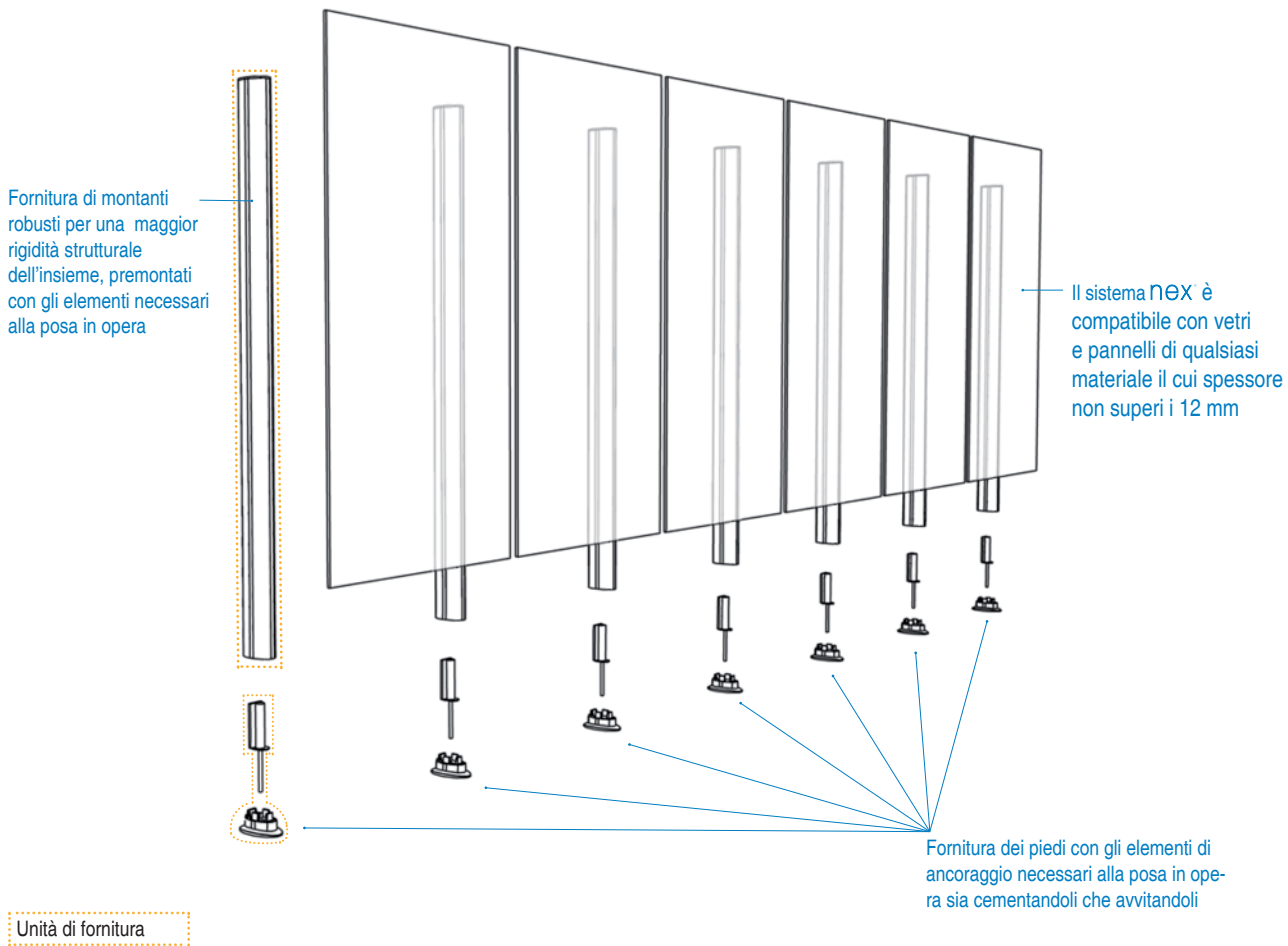



DATA TECNICOI

PERNO

In acciaio inox, ammette qualsiasi inclinazione fino a 40°. La giunzione tra il corrimano e il montante è invisibile dall'esterno. Cod.: 530001



PERNO E ARTICOLAZIONE NEL LEGNO

In acciaio inox inserito nel legno, ospita il perno che unisce il corrimano al montante.

Inclinazione massima $\pm 40^\circ$. Cod.: 530002



UNIONE ARTICOLATA

Per il fissaggio delle barre trasversali ai montanti.

Ruota a 360°. Cod.: 530003



ANGOLI E TAPPI

I raccordi ad angolo dei corrimano si possono risolvere in due modi:

Barra curva

Cod.: 530008



Angolo retto



TAPAS

**Tappi per i
profili semplici**

Cod.: 520001



**Tappi per i
profili robusti**

Cod.: 520002



RACCORDO LONGITUDINALE

Unisce barre trasversali e corrimano. Semplifica la sostituzione di qualsiasi segmento. Cod.: 530010

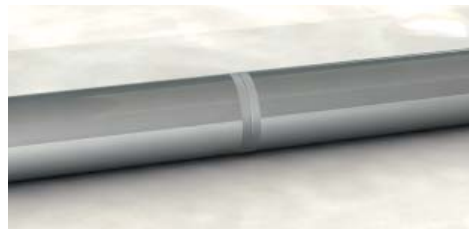

FISSAGGIO A PARETE

Mediante sistema "Bal-Rot" in apertura di facciata (balconi e parapetti), permette una tolleranza di 3 cm. Cod.: 530009



UNIONI DI PROFILI LEGGERI E ROBUSTI

Permette di combinare tutti i profili della gamma utilizzando gli stessi accessori.



SUPPORTO PER IL CAVO

In acciaio inox, per cavi d'acciaio di sezione compresa tra 3 e 4 mm. Cod.: 530004



FISSAGGIO DI VETRI E PANNELLI

Morsetto

Fissa al pavimento vetri e pannelli (spessi 6 o 10 mm), è regolabile su tre assi. Cod.: 530007



Pinza

Fissa vetri e pannelli (spessi 8, 10 o 12 mm) che rimangono sospesi. Tolleranza di 135°.

Semplice

Cod.: 530006

Doppia

Cod.: 530005



PIEDI DI ANCORAGGIO LEGGERI E ROBUSTI

Piede leggero semplice (Cod.: 530011) da avvitare al pavimento.

Piede leggero da cementare (Cod.: 530012) include un tubo da interrare, poggia su di una base coprigiunti.

Piede leggero articolato (Cod.: 530013) si adatta all'inclinazione del suolo su tre assi. Il meccanismo permette una tolleranza frontale di $\pm 4^\circ$, laterale di $\pm 7^\circ$ e verticale di 30 mm.

Fissaggio alla soletta (Cod.: 530014) con ancoraggio verticale per fissare i montanti al bordo della soletta o sul piano verticale di un muro.



Cod.: 530011



Cod.: 530012



Cod.: 530013



Cod.: 530014

Piede robusto da cementare (Cod.: 530015) include un tubo da interrare, poggia su di una base coprigiunti.

Piede robusto semplice (Cod.: 530016) da avvitare al pavimento.

Piede robusto articolato (Cod.: 530017) si adatta all'inclinazione del suolo con una tolleranza frontale di $\pm 4^\circ$ e laterale di $\pm 7^\circ$.

Montaggio diretto di lastre di vetro o pannelli spessi 6 o 10 mm (Cod.: 530017) su uno, due o tre lati dei montanti robusti.



Cod.: 530015



Cod.: 530016



Cod.: 530017

GAMMA COLORI

ANODIZZATI



Grigio metallico

LEGNI MASSICCI



Castagno



Iroko

LACCATI

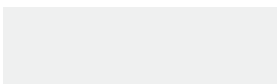

RAL 9010

* Per altri colori contattare l'Ufficio
Tecnico.

LACCATO METALLIZZATO TESTURIZZATO



Grigio metallo



Grigio sablé



Corten

SUBLIMATI EFFETTO METALLO



Corten

SUBLIMATI EFFETTO LEGNO



Cedro



Noce



Sapelli

GESTIONE E CONSEGNA

GESTIONE TECNICA

Informazione precisa dei nostri prodotti con file editabili per gestire il Suo progetto

- Grafici DWG
- File 3D
- Memoria descrittiva
- Unità valutate



UFFICIO TECNICO

Trenza Metal Área vanta una ricca esperienza nell'applicazione dei suoi prodotti in cantiere ed offre gratuitamente il suo servizio tecnico ad architetti, ingegneri, costruttori, promotori e tecnici comunali. Oltre 1.500 installazioni confermano il prestigio crescente della nostra azienda e l'affidabilità di prodotti e sistemi.

FORNITURA DEI PRODOTTI PREMONTATI E SU MISURA

La **struttura modulare** rende l'imballaggio e la fornitura dei prodotti del sistema **nEX** **specialmente semplici**. Il cliente riceve infatti tutti gli elementi **premontati**, tagliati su misura e **pronti per l'installazione**.

La **rotula Tub Metal** costituisce un meccanismo innovativo che permette di adattare tutte le configurazioni fino a 40° di **inclinazione**, **non richiede meccanizzazioni** e può essere installato da personale non qualificato.



INSTALLAZIONE

L'installazione e la riparazione sono facili, comode e di rapida esecuzione. Il sistema TubMetal prevede due opzioni di ancoraggio al suolo: **cementazione o avvitanimento**. Tre tasselli ancorano stabilmente gli elementi al pavimento o al bordo esterno della soletta. La novità del sistema è che **anche se cementato è ancora smontabile**: caratteristica che favorisce le riparazioni, che non richiedono l'intervento di personale qualificato. **Il sistema.**

Tubmetal non comprende saldature né adesivi per il fissaggio dei punti di unione: tutte le giunzioni vengono fissate con l'impiego di viti inossidabili o occulte, permettendo di considerare il sistema TubMetal un **elemento antivandalico**.



TRENZA METAL ÁREA

Ufficio Tecnico

(+39) 06 5483 2835

www.tubmetal.com

www.trenzametalarea.com

**Richieda il CD con la
documentazione completa dei
nostri prodotti: cataloghi in PDF,
grafici DWG, listini...**



ITALIA

Trenza Metal Área
Viale Luca Gaurico, 9/11
00143 Roma
ITALIA
Tel.: +39 06 5483 2835
Fax: +39 06 5483 4000
e-mail: info.it@trenzametal.com

DEUTSCHLAND

Trenza Metal Área
Friedrichstraße 50
10117 Berlin
DEUTSCHLAND
Tel.: +49-30-20659-414
Fax: +49-30-20659-200
e-mail: info.de@trenzametal.com

FRANCE

Trenza Metal Área
Le Dôme
1, rue de La Haye – BP 12910
95731 ROISSY CDG CEDEX
FRANCE
Tél.: +33 (0)1 49 19 21 75
Fax: +33 (0)1 49 19 21 00
e-mail: info.fr@trenzametal.com

ESPAÑA

Trenza Metal Área
Polígono Industrial Valcabado
Ctra. N-630, Km. 272.
49024 Zamora
ESPAÑA
Tel.: (+34) 980 509 219
Fax: (+34) 980 530 692
e-mail: info@trenzametal.com

